

## All India Aakash Test Series for NEET-2020

**TEST - 3 (Code-A)**

Test Date : 10/11/2019

**ANSWERS**

1. (1)	37. (2)	73. (3)	109. (3)	145. (2)
2. (3)	38. (4)	74. (1)	110. (4)	146. (3)
3. (1)	39. (4)	75. (2)	111. (1)	147. (3)
4. (3)	40. (3)	76. (3)	112. (3)	148. (4)
5. (3)	41. (1)	77. (1)	113. (2)	149. (3)
6. (1)	42. (2)	78. (3)	114. (4)	150. (4)
7. (4)	43. (2)	79. (3)	115. (1)	151. (3)
8. (2)	44. (1)	80. (4)	116. (2)	152. (1)
9. (1)	45. (3)	81. (2)	117. (4)	153. (3)
10. (4)	46. (1)	82. (1)	118. (3)	154. (1)
11. (3)	47. (3)	83. (4)	119. (1)	155. (1)
12. (4)	48. (2)	84. (3)	120. (2)	156. (4)
13. (1)	49. (1)	85. (2)	121. (3)	157. (4)
14. (3)	50. (3)	86. (2)	122. (4)	158. (3)
15. (3)	51. (1)	87. (1)	123. (1)	159. (1)
16. (1)	52. (2)	88. (4)	124. (2)	160. (3)
17. (3)	53. (3)	89. (3)	125. (3)	161. (3)
18. (3)	54. (3)	90. (2)	126. (1)	162. (2)
19. (4)	55. (1)	91. (2)	127. (2)	163. (1)
20. (4)	56. (4)	92. (1)	128. (1)	164. (3)
21. (2)	57. (4)	93. (4)	129. (4)	165. (2)
22. (3)	58. (2)	94. (4)	130. (1)	166. (4)
23. (1)	59. (1)	95. (3)	131. (3)	167. (1)
24. (3)	60. (3)	96. (3)	132. (2)	168. (3)
25. (4)	61. (4)	97. (2)	133. (1)	169. (4)
26. (1)	62. (2)	98. (3)	134. (2)	170. (2)
27. (3)	63. (3)	99. (3)	135. (3)	171. (1)
28. (4)	64. (2)	100. (2)	136. (4)	172. (2)
29. (3)	65. (1)	101. (1)	137. (1)	173. (3)
30. (2)	66. (3)	102. (4)	138. (3)	174. (4)
31. (3)	67. (3)	103. (2)	139. (2)	175. (2)
32. (2)	68. (2)	104. (3)	140. (1)	176. (3)
33. (1)	69. (1)	105. (1)	141. (1)	177. (4)
34. (3)	70. (4)	106. (2)	142. (2)	178. (2)
35. (4)	71. (1)	107. (2)	143. (4)	179. (4)
36. (1)	72. (3)	108. (2)	144. (4)	180. (2)

## HINTS & SOLUTIONS

### PHYSICS

1. Answer (1)

**Hint :**  $\vec{v}_{IO} = \vec{v}_{IM} - \vec{v}_{OM}$

**Sol. :**  $\vec{v}_{OM} = (4\hat{i} + 4\hat{j}) \text{ m/s}$

$\vec{v}_{IM} = (-4\hat{i} + 4\hat{j}) \text{ m/s}$

$\vec{v}_{IO} = (-4\hat{i} + 4\hat{j}) - (4\hat{i} + 4\hat{j})$

$\vec{v}_{IO} = -8\hat{i} \text{ m/s}$

2. Answer (3)

**Hint :** Use Snell's law

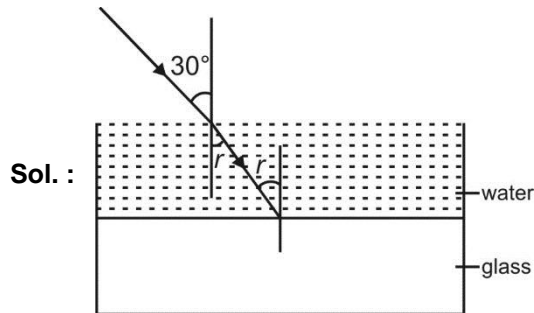

$$\frac{\sin 30^\circ}{\sin r} = \frac{\mu_w}{\mu_g}$$

$$\frac{1}{2 \sin r} = \frac{4}{3}$$

$$\sin r = \frac{3}{8}$$

$$r = \sin^{-1}\left(\frac{3}{8}\right)$$

3. Answer (1)

**Hint and Sol. :** Lens Maker's formula is applicable to thin lenses and paraxial rays which subtend very small angle with principle axis.

4. Answer (3)

**Hint :** For normal adjustment length of the tube

$$L = f_e + f_o$$

**Sol. :**  $m = \frac{f_o}{f_e}$

$$15 = \frac{f_o}{f_e}$$

$$f_o = 15f_e$$

$$80 = f_e + 15f_e$$

$$f_e = 5 \text{ cm}$$

$$80 = 5 + f_o$$

$$f_o = 75 \text{ cm}$$

5. Answer (3)

**Hint :** Dispersive power =  $\frac{\mu_V - \mu_R}{\mu_Y - 1}$

**Sol. :**  $\omega = \frac{1.704 - 1.690}{1.694 - 1}$

$$= \frac{0.014}{0.694}$$

$$\approx 0.02017$$

$$\approx 0.020$$

6. Answer (1)

**Hint :** Lateral displacement by parallel faced slab.

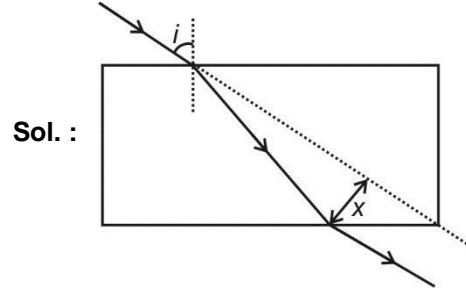

$$x = \frac{t \sin(i - r)}{\cos r}$$

$$5 = 5 \frac{\sin(i - r)}{\cos r}$$

$$\cos r = \sin(i - r)$$

$$\sin(90^\circ - r) = \sin(i - r)$$

$$90^\circ - r = i - r$$

$$i = 90^\circ$$

7. Answer (4)

**Hint :**  $\frac{\mu_1}{f} = (\mu_2 - \mu_1) \left( \frac{1}{R_1} - \frac{1}{R_2} \right)$

**Sol. :** In air

$$\frac{1}{f} = \left( \frac{4}{3} - 1 \right) \left( \frac{1}{R_1} - \frac{1}{R_2} \right)$$

In glass

$$\frac{3}{2} = \left( \frac{4}{3} - \frac{3}{2} \right) \left( \frac{1}{R_1} - \frac{1}{R_2} \right)$$

$$\frac{3}{2f_1} = \left( \frac{4}{3} - \frac{3}{2} \right) \left( \frac{1}{R_1} - \frac{1}{R_2} \right)$$

$$\frac{3f}{2f_1} = -\frac{1}{2}$$

$$f_1 = -3f$$

Focal length becomes 3f and nature will be diverging.

8. Answer (2)

**Hint :** Apply Snell's law and prism formula.

**Sol. :**  $\frac{\mu_2}{\mu_1} = \frac{\sin i}{\sin(r)}$

for minimum deviation

$$i = \frac{A + \delta_m}{2}$$

$$r = \frac{A}{2}$$

$$\frac{3}{\sqrt{3}} = \frac{\sin\left(\frac{60^\circ + \delta_m}{2}\right)}{\sin 30^\circ}$$

$$\frac{\sqrt{3}}{2} = \sin\left(\frac{60^\circ + \delta_m}{2}\right)$$

$$\frac{60^\circ + \delta_m}{2} = 60^\circ$$

$$\delta_m = 60^\circ$$

9. Answer (1)

**Hint :** Use  $\frac{1}{v} + \frac{1}{u} = \frac{1}{f}$  and  $m = -\frac{v}{u}$

**Sol. :** For virtual image

$$m = -\frac{v}{u} = \frac{l}{O}$$

$$v = -2u$$

$$\frac{1}{v} + \frac{1}{u} = \frac{1}{f}$$

$$\frac{1}{-2u} + \frac{1}{u} = \frac{1}{-10}$$

$$\frac{1}{2u} = -\frac{1}{10}$$

$$u = -5 \text{ cm}$$

For real image

$$\frac{1}{v} + \frac{1}{u} = \frac{1}{f}$$

$$\frac{1}{2u} + \frac{1}{u} = \frac{1}{-10}$$

$$\frac{3}{2u} = -\frac{1}{10}$$

$$u = -15 \text{ cm}$$

$$x = |-15| - |-5| = 10 \text{ cm}$$

10. Answer (4)

**Hint :** Image formed by both plane mirror and convex mirror at same point

**Sol. :**

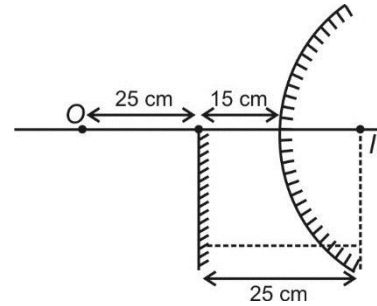

Image formed by plane mirror will be at distance of 25 cm from plane mirror and 10 cm from the pole of convex mirror. By mirror formula.

$$\frac{1}{v} + \frac{1}{u} = \frac{1}{f}$$

$$\frac{1}{+10} - \frac{1}{40} = \frac{1}{f}$$

$$\frac{4-1}{40} = \frac{1}{f}$$

$$f = \frac{40}{3} \text{ cm}$$

$$R = 2f$$

$$= \frac{80}{3} \text{ cm}$$

11. Answer (3)

**Hint :** Magnification will be minimum when image will formed at infinity.

**Sol. :**  $M = \frac{v_0 D}{u_0 f_e}$

$$M' = \frac{v_0 D}{u_0 \left(\frac{f_e}{2}\right)}$$

$$= 2M$$

12. Answer (4)

**Hint and Sol. :** Total internal reflection will occur if ray travel from denser to rarer medium. Let refractive index of medium A, B and C are  $\mu_1$ ,  $\mu_2$  and  $\mu_3$  respectively

$$\mu_1 > \mu_2 > \mu_3$$

$$C_1 < C_2 < C_3$$

13. Answer (1)

**Hint :** Ray will be undeviated if incident ray and emergent ray will be parallel to each other.

**Sol. :** Incident rays and emergent rays will be parallel if refracted rays from convex lens meet at the focus of concave lens.

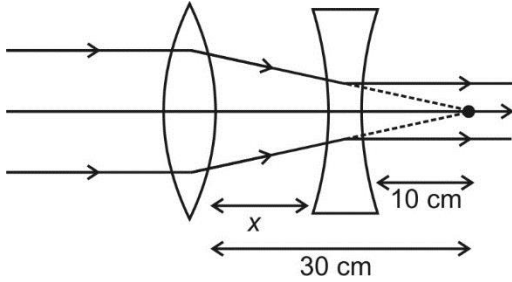

$$x = 30 - 10$$

$$x = 20 \text{ cm}$$

14. Answer (3)

**Hint and Sol. :**

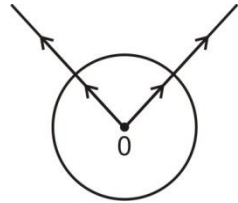

The rays from the object fall normally on the surface of sphere and emerge undeviated. When drawn backwards, they will meet at O. The image will form at center itself.

15. Answer (3)

**Hint :**  $v_{Ix} = mv_{Ox}$

$$v_{Iy} = -m^2 v_{Oy}$$

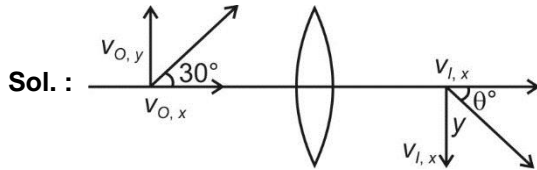

**Sol. :**

$$\text{At } x = 30 \text{ cm}$$

$$m = 1$$

$$v_{Ix} = v_{Ox}$$

$$v_{Iy} = v_{Oy}$$

$$\tan \theta = -\frac{v_{Oy}}{v_{Ox}}$$

$$\tan \theta = -\tan 30^\circ$$

$$\theta = -30^\circ$$

16. Answer (1)

**Hint :**  $m = -\frac{v}{u}$  and

$$\frac{1}{v} + \frac{1}{u} = \frac{1}{f}$$

**Sol. :** 
$$\frac{1}{f} = \frac{1}{v} + \frac{1}{u}$$

$$\frac{1}{-20} = \frac{1}{v} - \frac{1}{30}$$

$$\frac{1}{v} = -\frac{1}{20} + \frac{1}{30}$$

$$= \frac{-3+2}{60}$$

$$v = -60 \text{ cm}$$

$$m = -\frac{60}{30} = -2$$

17. Answer (3)

**Hint and Sol. :** Total internal reflection is used in optical fiber for transmission of light energy.

18. Answer (3)

**Hint :** The image of an object at 25 cm, should form at 50 cm.

**Sol. :**  $u = -25 \text{ cm}$

$$v = -50 \text{ cm}$$

$$\frac{1}{f} = \frac{1}{v} - \frac{1}{u}$$

$$\frac{1}{f} = \frac{1}{-50} + \frac{1}{25}$$

$$f = 50 \text{ cm (convex lens)}$$

19. Answer (4)

**Hint :** Use Snell's law

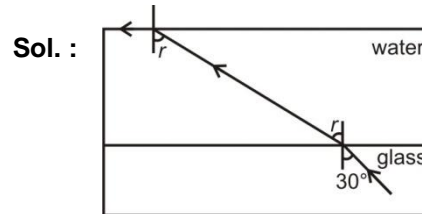

**Sol. :**

At glass water interface

$$\frac{\sin 30^\circ}{\sin r} = \frac{\mu_w}{\mu_g} \quad \dots(i)$$

At water air interface

$$\sin r = \frac{1}{\mu_w} \quad \dots(ii)$$

Equation (i) and (ii)

$$\sin 30^\circ = \frac{1}{\mu_g}$$

$$\frac{1}{2} = \frac{1}{\mu_g}$$

$$\mu_g = 2$$

20. Answer (4)

**Hint :** Use  $\frac{1}{f} = \frac{1}{f_1} + \frac{1}{f_2}$

Sol. :  $\frac{f_{\text{convex}}}{f_{\text{concave}}} = \frac{2}{3}$

$$\frac{1}{f} = \frac{1}{f_{\text{convex}}} + \frac{1}{f_{\text{concave}}}$$

$$\frac{1}{30} = \frac{1}{f_{\text{convex}}} - \frac{1}{\frac{3}{2}f_{\text{convex}}}$$

$$\frac{1}{30} = \frac{1}{f_{\text{convex}}} - \frac{2}{3f_{\text{convex}}}$$

$$\frac{1}{30} = \frac{1}{3f_{\text{convex}}}$$

$$f_{\text{convex}} = 10 \text{ cm}$$

$$f_{\text{concave}} = -\frac{3}{2}f_{\text{convex}}$$

$$= -\frac{3}{2} \times 10$$

$$= -15 \text{ cm}$$

21. Answer (2)

Hint :  $I_R = I_1 + I_2 + 2\sqrt{I_1 \times I_2} \cos \phi$ ,  $\frac{I_1}{I_2} = \frac{b_1}{b_2}$

Sol. :  $I_{\text{max}} = I + 4I + 2 \times 2I$

$$I_0 = I_{\text{max}} = 9I$$

$$I = \left(\frac{I_0}{9}\right)$$

At  $\phi = 60$

$$I_R = I + 4I + 4I \times \frac{1}{2}$$

$$I_R = 7I$$

$$I_R = \frac{7I_0}{9}$$

22. Answer (3)

Hint : For maxima  $x = \frac{n\lambda D}{d}$

For minima  $x = \frac{(2n+1)\lambda D}{2d}$ ,  $n = 0, 1, 2, \dots$

Sol. :  $x_{2B} = \frac{2\lambda D}{d}$

$$x_{5D} = \frac{9\lambda D}{2d}$$

$$x_{5D} - x_{2B} = \frac{5\lambda D}{2d}$$

$$5 \times 10^{-3} = \frac{5}{2} \times \frac{100 \times 10^{-2}}{0.3 \times 10^{-3}} \times \lambda$$

$$\lambda = 6 \times 10^{-7}$$

$$\lambda = 600 \times 10^{-9}$$

$$\lambda = 600 \text{ nm}$$

23. Answer (1)

Hint :  $L = \frac{N\lambda_0 D}{\mu d}$

Sol. :  $L = \frac{N\lambda_0 D}{\mu d}$

$$N = \mu \frac{Ld}{\lambda_0 D}$$

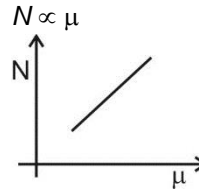

24. Answer (3)

Hint and Sol. : The amount of bending of light depend upon the size of the obstacle and wavelength of light used.

25. Answer (4)

Hint and Sol. : Huygen's principle is used to prove the laws of reflection and refraction.

26. Answer (1)

Hint : When light wave travels from one medium to another medium wavelength of light will change while frequency remains same.

Sol. :  $v_1 = v$

$$\lambda_1 = \frac{\lambda}{\mu}$$

$$= \frac{\lambda}{\frac{4}{3}}$$

$$= \frac{3\lambda}{4}$$

27. Answer (3)

Hint : Resolving power  $\propto \frac{1}{\lambda}$

Sol. :  $\frac{R \cdot P_1}{R \cdot P_2} = \frac{\lambda_2}{\lambda_1} = \frac{6000 \text{ \AA}}{4500 \text{ \AA}} = \frac{4}{3}$

28. Answer (4)

Hint : Between two first minima on either side central maxima will form.

Sol. :  $W = \frac{2\lambda D}{d}$

$$W = \frac{2 \times 400 \times 10^{-9} \times 2}{2 \times 10^{-3}}$$

$$W = 8 \times 10^{-4}$$

$$W = 800 \times 10^{-6}$$

$$W = 800 \text{ \mu m}$$

29. Answer (3)

Hint :  $I_1 = I \cos^2 \phi$

**Sol. :** After rotating  $30^\circ$  angle between axes of two polaroids becomes  $60^\circ$ .

$$I = \frac{I_0}{2} \cos^2 60^\circ$$

$$I = \frac{I_0}{8}$$

$$\%I = \frac{I}{I_0} \times 100$$

$$= \frac{1}{8} \times 100$$

$$= 12.5\%$$

30. Answer (2)

**Hint and Sol. :** The synthetic material used for the preparation of polaroids possess the property of dichroism.

31. Answer (3)

**Hint :**  $\mu = \tan i_p$

**Sol. :**  $\sin i_c = \frac{1}{\mu}$

$$\frac{1}{\mu} = \sin 60^\circ$$

$$\mu = \frac{2}{\sqrt{3}}$$

$$i_p = \tan^{-1} \left( \frac{2}{\sqrt{3}} \right)$$

32. Answer (2)

**Hint :** Power factor  $\cos \phi = \frac{R}{Z}$

**Sol. :**  $Z = \sqrt{R^2 + (X_C)^2}$

$$= \sqrt{R^2 + \left( \frac{1}{\omega C} \right)^2}$$

$$\cos \phi = \frac{R}{\sqrt{R^2 + \left( \frac{1}{\omega C} \right)^2}}$$

$$= \frac{R\omega C}{\sqrt{(R\omega C)^2 + 1}}$$

33. Answer (1)

**Hint :**  $I = \frac{V}{Z}$ ,  $V_C = IX_C$

**Sol. :**  $Z = \sqrt{R^2 + (X_C - X_L)^2}$

$$Z = \sqrt{(40)^2 + (50 - 20)^2}$$

$$= 50 \Omega$$

$$I = \frac{250}{50}$$

$$I = 5 \text{ A}$$

$$V_C = IX_C$$

$$= 5 \times 50$$

$$V_C = 250 \text{ V}$$

34. Answer (3)

**Hint :**  $I_{r.m.s} = \sqrt{\frac{\int I^2 dt}{\int dt}}$

**Sol. :**  $I_{r.m.s} = \sqrt{\frac{\int I^2 dt}{\int dt}}$

$$I_{m.s} = \frac{\int_0^T (3t^2)^2 dt}{\int_0^T dt}$$

$$= \frac{9 \int_0^T t^4 dt}{T}$$

$$= \frac{9}{5} T^4$$

$$I_{r.m.s} = \sqrt{I_{m.s}}$$

$$= \frac{3}{\sqrt{5}} T^2$$

35. Answer (4)

**Hint :** Voltage across inductor leads the current.

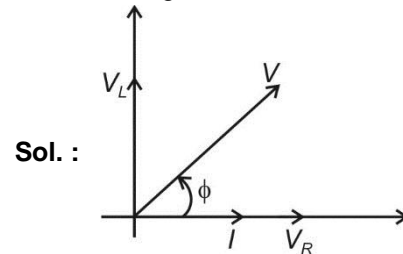

$$X_L = \omega L$$

$$= 200 \times 100 \times 10^{-3}$$

$$= 20 \Omega$$

$$\tan \phi = \frac{V_L}{V_R} = \frac{X_L}{R} = \frac{20}{20} = 1$$

$$\phi = \frac{\pi}{4}$$

36. Answer (1)

**Hint and Sol. :** A choke coil has high inductance and low resistance.

37. Answer (2)

**Hint :** At any time( $t$ ) voltage drop across the capacitor plus voltage drop across the inductor will be zero.

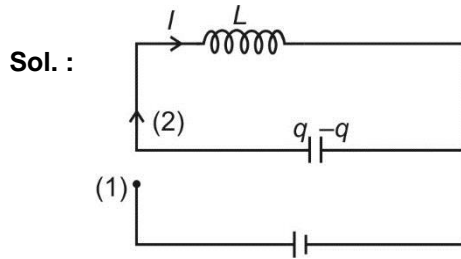

$$V_L + V_C = 0$$

$$-L \frac{dI}{dt} + V_C = 0$$

$$I = -\frac{dq}{dt}$$

$$L \frac{d^2q}{dt^2} + \frac{q}{C} = 0$$

$$\frac{d^2q}{dt^2} + \frac{q}{LC} = 0$$

38. Answer (4)

**Hint :**  $E_p = \frac{-d\phi_p}{dt}$  and  $\frac{E_s}{E_p} = \frac{N_s}{N_p}$

**Sol. :**  $E_p = -500 \frac{d}{dt}(2 + 2t)$

$$= -1000 \text{ V}$$

$$|E_p| = 1000 \text{ V}$$

$$\frac{E_s}{E_p} = \frac{N_s}{N_p}$$

$$E_s = \frac{1000}{500} \times 1000$$

$$E_s = 2000 \text{ V}$$

39. Answer (4)

**Hint :**  $X_C = \frac{1}{\omega C}$

**Sol. :**  $R = \frac{V^2}{P}$

$$R = \frac{(100)^2}{100}$$

$$R = 100 \Omega$$

$$P = VI$$

$$I = \frac{100}{100}$$

$$I = 1 \text{ A}$$

Current in the circuit without capacitor

$$I = \frac{V}{R}$$

$$I = \frac{200}{100}$$

$$I = 2 \text{ A}$$

To reduce the current 1 A capacitor can be added.

$$I = \frac{V}{\sqrt{R^2 + (X_C)^2}}$$

$$I = \frac{200}{\sqrt{(100)^2 + (X_C)^2}}$$

$$(100)^2 + X_C^2 = (200)^2$$

$$X_C^2 = 40000 - 10000$$

$$X_C = \sqrt{3} \times 100$$

$$\frac{1}{\omega C} = \sqrt{3} \times 100$$

$$C = \frac{1}{100\pi \times \sqrt{3} \times 100}$$

$$C = 18 \mu\text{F}$$

40. Answer (3)

**Hint :**  $I = \frac{V}{Z}$

**Sol. :** When L is removed

$$\tan \phi_1 = \frac{X_C}{R}$$

When C is removed

$$\tan \phi_2 = \frac{X_L}{R}$$

Given  $\phi_1 = \phi_2$

$$\frac{X_L}{R} = \frac{X_C}{R}$$

$X_L = X_C$  this is the condition of resonance

So,  $Z = R$

$$I = \frac{V}{R}$$

$$I = \frac{100}{50}$$

$$I = 2 \text{ A}$$

41. Answer (1)

**Hint and Sol. :** Direction of propagation of EM wave will be in the direction of  $\vec{E} \times \vec{B}$  therefore direction of propagation will be perpendicular to both  $\vec{E}$  and  $\vec{B}$ .

42. Answer (2)

**Hint :**  $\Delta p = \frac{Pt}{c}$

**Sol. :**  $p_f - p_i = \frac{20 \times 10^{-3} \times 6 \times 10^{-9}}{3 \times 10^8}$

$$P_f = 40 \times 10^{-20}$$

$$P_f = 4.0 \times 10^{-19} \text{ kg m/s}$$

43. Answer (2)

**Hint :**  $B_0 = \mu_0 H_0$

**Sol. :**  $B_0 = \frac{E_0}{c}$

$$\frac{E_0}{c} = \mu_0 H_0$$

$$\sqrt{\mu_0 \epsilon_0} E_0 = \mu_0 H_0$$

$$H_0 = E_0 \sqrt{\frac{\epsilon_0}{\mu_0}}$$

44. Answer (1)

**Hint :**  $B = \frac{\mu_0 I}{2\pi R^2} r$

**Sol. :**  $B = \frac{4\pi \times 10^{-7} \times \pi \times 0.1}{2\pi \times \left(\frac{2}{10}\right)^2}$

$$B = \frac{2\pi \times 10^{-6}}{4}$$

$$B = 0.5\pi \times 10^{-6}$$

$$B = 5\pi \times 10^{-7} \text{ T}$$

45. Answer (3)

**Hint :**  $I_d = i_C = C \frac{dV}{dt}$

**Sol. :**  $I_d = C \frac{dV}{dt}$   
 $= 2 \times 10^{-6} \times 10^4$   
 $= 2 \times 10^{-2}$   
 $= 20 \text{ mA}$

## CHEMISTRY

46. Answer (1)

**Hint :** Brass contains copper and zinc.

47. Answer (3)

**Hint:**  $d^0$  and  $d^{10}$  configurations do not involve d-d transition.

**Sol.:** In purple coloured  $\text{MnO}_4^-$ , Mn has no d electron. So, d-d transition is not possible. All other three ions are coloured due to d-d transition.  $\text{MnO}_4^-$  shows colour due to charge transfer

48. Answer (2)

**Hint:**

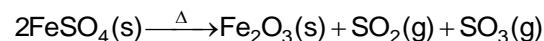

49. Answer (1)

**Hint:** In lower oxidation state of metal, oxides show more basic character.

50. Answer (3)

**Hint:**  $E = \frac{M}{n - \text{factor}}$

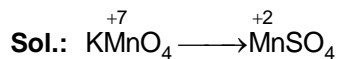

$\therefore$  n factor = 5, hence,  $E = M/5$

51. Answer (1)

**Hint:**  $\mu = \sqrt{n(n+2)} \text{ BM}$

**Sol.:**  $\mu = \sqrt{n(n+2)} \text{ BM} = 5.916 \text{ BM}$

$\therefore n = 5$

For, Fe(26) :  $[\text{Ar}]3d^64s^2$

$\text{Fe}^{3+}$  :  $[\text{Ar}]3d^5$  has 5 unpaired electrons

52. Answer (2)

**Hint:** Acidified  $\text{K}_2\text{Cr}_2\text{O}_7$  oxidises sulphides into sulphur.

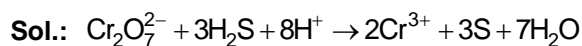

53. Answer (3)

**Hint:**

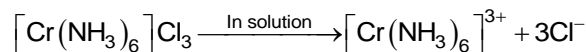

So, 3 moles of AgCl will be precipitated.

54. Answer (3)

**Hint:** Mn shows +2 to +7 oxidation states.

55. Answer (1)

**Hint:**  $\text{Ti}^{4+}$  has  $d^0$  configuration, hence colourless.

56. Answer (4)

**Hint:** Lanthanoid hydroxides are less basic than alkali metal hydroxides.

57. Answer (4)

**Hint :**

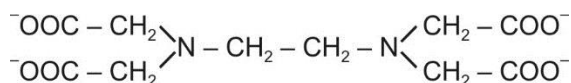

**Sol. :** EDTA can donate maximum 6 electron pairs, so its maximum number of coordination sites is 6.

58. Answer (2)

**Hint :**  $\text{EAN} = Z - \text{O. S.} + 2 \times \text{C.N.}$

**Sol. :** EAN of Cr =  $24 - 3 + 2 \times 6 = 33$

59. Answer (1)

**Hint:** Primary valency is equal to the oxidation number of the metal in complex.

**Sol.:** In  $[\text{Ni}(\text{CO})_4]$  oxidation number of Ni is zero.

60. Answer (3)

**Hint :** In tetrahedral complex, splitting is lesser as compared to octahedral field splitting.

**Sol. :**  $\Delta_0 = \frac{9}{4} \Delta_t$



61. Answer (4)

**Hint :** More the charge density on central metal and more the chelation, more will be  $\Delta_0$ .

62. Answer (2)

**Hint:** Ziegler Natta catalyst :  $\text{TiCl}_4 + (\text{C}_2\text{H}_5)_3\text{Al}$ .

63. Answer (3)

**Hint:** Square planar complex  $[\text{Mabcd}]$  has three geometrical isomers as ligand a may have b, c or d to its trans position.

64. Answer (2)

**Hint :**  $\text{NO}_2^-$  is an ambidentate ligand.

$\text{NO}_2^-$  can be bonded through either N atom or O atom.

65. Answer (1)

**Hint:** Weak field ligand complexes are generally high spin and outer orbital.

**Sol.:** In  $[\text{CoF}_6]^{3-}$ ,  $\text{Co}^{3+}$  ion has  $3d^6$  configuration and since  $\text{F}^-$  is a weak field ligand hence it acquires  $sp^3d^2$  hybridisation and is outer orbital complex.

66. Answer (3)

**Hint :** Fluoroalkanes undergo elimination via  $\text{E}_{1\text{cB}}$  mechanism.

**Sol. :**

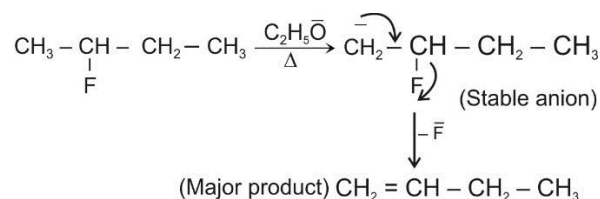

67. Answer (3)

**Hint:** Vinylic carbocation is highly unstable.

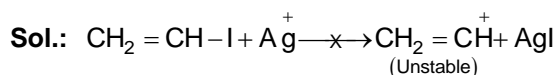

Hence yellow  $\text{AgI}$  ppt. is not obtained in this case.

68. Answer (2)

**Hint:** Rate of  $\text{S}_{\text{N}}1$  reaction  $\propto$  Stability of carbocation

**Sol.:** Relative stabilities of carbocation is

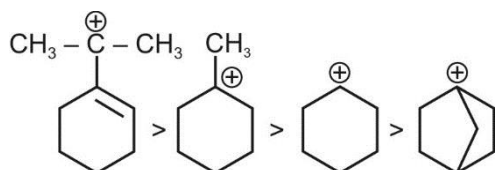

Bridgehead carbocation is least stable.

69. Answer (1)

**Hint:** Dipole moment = Charge  $\times$  bond length

**Sol.:** Since  $\text{C} - \text{Cl}$  bond length  $>$   $\text{C} - \text{F}$  bond length

$\therefore$   $\text{CH}_3\text{Cl}$  has greater dipole moment than that of  $\text{CH}_3\text{F}$ .

70. Answer (4)

**Hint :** The reaction follows benzyne mechanism.

**Sol. :**

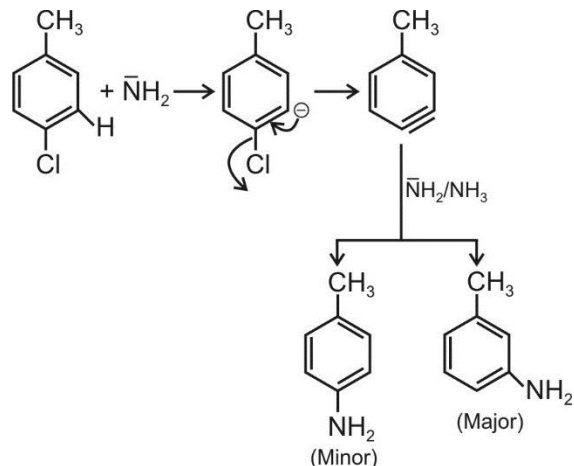

71. Answer (1)

**Hint:** Swarts reaction

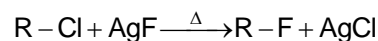

72. Answer (3)

**Hint:** Boiling point  $\propto$  Surface area.

**Sol. :** Primary alkyl group has larger surface area than that of isomeric secondary and tertiary alkyl groups.

73. Answer (3)

**Hint:** Preparation of alkyl benzene from aryl halide and alkyl halide using  $\text{Na}$ /dry ether is known as Wurtz-Fittig reaction.

74. Answer (1)

**Hint :**  $\text{C} - \text{X}$  bond has partial double bond character in vinyl bromide and bromobenzene.

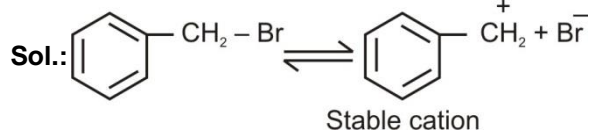

Also since  $\text{C} - \text{Br}$  bond is weaker than  $\text{C} - \text{Cl}$  bond, so  $\text{C} - \text{Br}$  bond is weakest in benzyl bromide.

75. Answer (2)

**Hint:** Phenol contains acidic hydrogen.

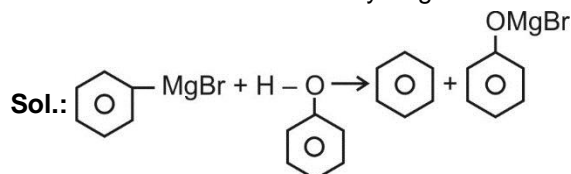

76. Answer (3)

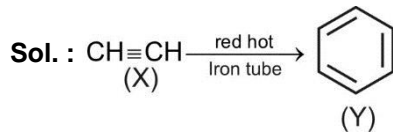
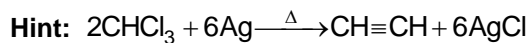

77. Answer (1)

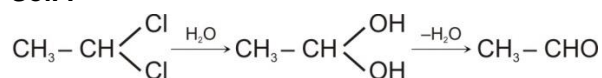
**Hint :** Gem-diols are unstable molecules.**Sol. :**

78. Answer (3)

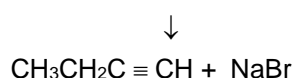
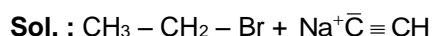
**Hint :** Acetylide ion is a good nucleophile.

79. Answer (3)

**Hint :**  $\text{CCl}_2$  intermediate is formed in Reimer Tiemann reaction.

80. Answer (4)

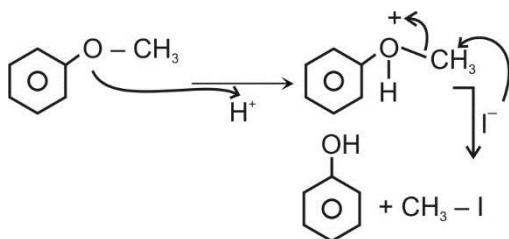
**Hint :** Cleavage of ether by  $\text{S}_\text{N}2$  mechanism.**Sol. :**

81. Answer (2)

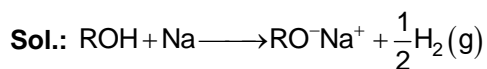
**Hint:** Reactions in which O-H bond of R-OH molecule is broken, exhibits acidic nature.

82. Answer (1)

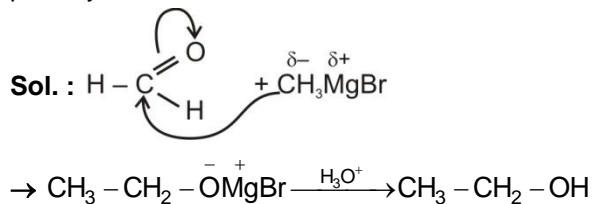
**Hint :** Grignard reagent on reaction with formaldehyde followed by hydrolysis gives primary alcohol.

83. Answer (4)

**Hint:** Order of acidic strength

Phenol &gt; Alcohols

84. Answer (3)

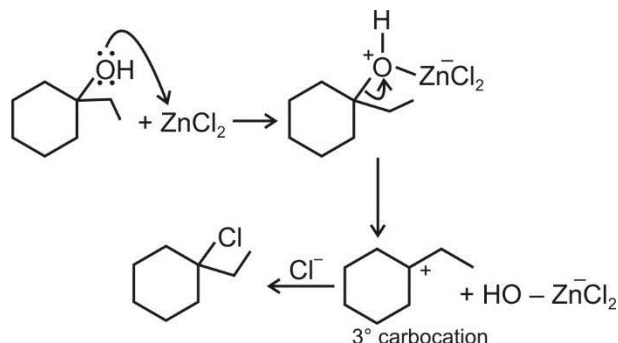
**Hint:**  $\text{ZnCl}_2/\text{HCl}$  is Lucas reagent.**Sol. :** Lucas reagent reacts fastest with tertiary alcohol.

85. Answer (2)

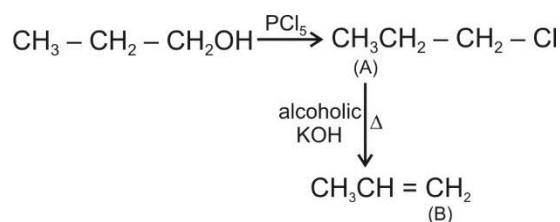
**Hint:**

86. Answer (2)

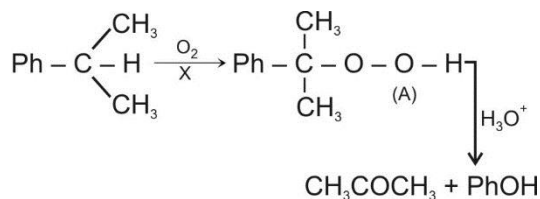
**Hint:** A is a hydroperoxide.

87. Answer (1)

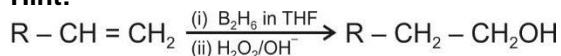
**Hint:**

This is called hydroboration-oxidation reaction.

88. Answer (4)



In this reaction R cannot be vinylic or a 3° alkyl group.

89. Answer (3)

**Hint:** Enantiomers are non-superimposable mirror images.

90. Answer (2)

**Hint :** Victor Meyer test is done to distinguish primary, secondary and tertiary alcohols.**Sol. :** Secondary alcohols give blue colouration in this test.

## BIOLOGY

91. Answer (2)  
**Hint :** A bhindi variety called Parbhani Kranti is resistant to viral disease.  
**Sol. :** It is resistant to yellow mosaic virus.
92. Answer (1)  
**Sol. :**  

Variety	Resistant to disease
a. Himgiri	– Hill bunt
b. Pusa Komal	– Bacterial blight
c. Karan rai	– White rust
d. Pusa sadabahar	– Leaf curl
93. Answer (4)  
**Hint :** Major component of biogas is highly inflammable.  
**Sol. :** Methanogens produce methane which contribute 50-70% of total biogas mixture.
94. Answer (4)  
**Sol. :** Baculoviruses attack insects and other arthropods hence are pathogens.  
*Trichoderma* are very common in root ecosystems.
95. Answer (3)  
**Sol. :** IRRI is situated in Philippines.
96. Answer (3)  
**Hint :** Niche is specific part of habitat occupied by individuals of a species.  
**Sol. :** Ecological niche of an organism represents the range of conditions that it can tolerate, the resources it utilises and its functional role in ecosystem.
97. Answer (2)  
**Hint :** In sigmoid curve of logistic growth initial lag phase is followed by acceleration and deceleration and finally an asymptote, where resources are limited.  
**Sol. :** An asymptote is shown when population density reaches the carrying capacity *i.e.* carrying capacity = population density.
98. Answer (3)  
**Sol. :** In some population interactions neither of the species is benefitted. In competition both the species are harmed (–, –).
99. Answer (3)  
**Hint :** It is a tissue which has cells in continuous state of division.  
**Sol. :** Meristem is free of virus and is used to obtain virus free plants.
100. Answer (2)  
**Sol. :**  
a. Totipotency – It is capacity to generate whole plant from any cell  
b. SCP – *Spirulina*  
c. Explant – Plant part which is cultured  
d. Callus – It is unorganised mass of cells in culture medium.
101. Answer (1)  
**Hint :** LAB (Lactic Acid Bacteria) play beneficial role in our stomach.  
**Sol. :** LAB improve nutritional quality of curd by increasing vit-B<sub>12</sub>. Besides this they play beneficial role in checking disease causing microbes in our stomach.  
Rest of the statements are true.
102. Answer (4)  
**Hint :** Cyclosporin-A is used during organ-transplant.  
**Sol. :** It is used as immunosuppressive agent.
103. Answer (2)  
**Sol. :** Lipases are obtained from yeast *Candida lipolytica* and *Geotrichum candidum*.
104. Answer (3)  
**Hint :** Conformers are not able to maintain homeostasis.  
**Sol. :** Maintenance of constancy of internal environment is called homeostasis. 99% animals and nearly all plants are conformers.
105. Answer (1)  
**Sol. :** According to Allen's rule, mammals from colder climates generally have shorter ears and limbs to minimise heat loss.
106. Answer (2)  
**Hint :** Population is number of individuals of a species in a particular area.  
**Sol. :** Population includes number of individuals of different ages. Plotting of age distribution for a population is called an age pyramid.
107. Answer (2)  
**Hint :** Eurythermals are not restricted to narrow range of temperatures.  
**Sol. :** They can tolerate and grow well in a wide range of temperature.
108. Answer (2)  
**Sol. :** Keolado National Park is situated in Bharatpur (Rajasthan).

109. Answer (3)

**Hint :** Per capita death is death rate.

**Sol. :** An individual may have birth and death but birth and death rates and sex ratio are characteristics of population not of an organism. Hence, birth rates, death rates and sex ratio are population attributes.

110. Answer (4)

**Sol. :** Breeding of crops with higher levels of vitamins and minerals or higher protein and healthier fats is called biofortification. It does not include improvement of carbohydrate quality.

111. Answer (1)

**Sol. :** Wheat variety Atlas 66 has high protein content.

112. Answer (3)

**Hint :** This vitamin is chemically known as cyanocobalamin.

**Sol. :** Curd contains number of vitamins especially B<sub>12</sub>.

113. Answer (2)

**Hint :** Large and small particles are removed from sewage by physical treatment.

**Sol. :** Primary sewage treatment is physical treatment. It includes filtration and sedimentation.

114. Answer (4)

**Sol. :** *Azotobacter* is a free living N<sub>2</sub>-fixing bacteria in soil.

115. Answer (1)

**Sol. :** Mixture of gases such as CH<sub>4</sub>, H<sub>2</sub>S and CO<sub>2</sub> is produced by bacteria in anaerobic sludge digester.

116. Answer (2)

**Hint :** BOD is the amount of oxygen that would be consumed if all the organic matter in one litre of water is oxidised by bacteria.

**Sol. :** If more is the organic matter in sewage water more will be the BOD. Thus, BOD is the indirect measure of the organic matter present in water.

117. Answer (4)

**Sol. :** In India, technology of biogas production was mainly developed by the efforts of Indian Agriculture Research Institute (IARI) and Khadi and Village Industries Commission (KVIC).

118. Answer (3)

**Hint :** *Oscillatoria* and *Aulosira* are cyanobacteria.

**Sol. :** These cyanobacteria (BGA) can fix nitrogen, thus increase soil fertility. *Rhizobium* is a symbiotic N<sub>2</sub>-fixing bacteria but *Propionibacterium sharmanii* bacterium is used in Swiss cheese production.

119. Answer (1)

**Hint :** Hypersaline and hyposaline terms are used to measure salt concentration of water bodies.

**Sol. :** Organisms which are restricted to a narrow range of salinities are called stenohaline.

120. Answer (2)

**Sol. :** The salt concentration (in parts per thousand) of sea water may range between 30-35.

121. Answer (3)

**Hint :** Desert lizards lack physiological ability to cope with extreme temperature. They manage body temperature by behavioural means.

**Sol. :** Ozone layer of stratosphere absorbs UV-C and half of the UV-B radiations.

Vegetation in any area is determined by soil composition and topography.

In a biome, regional and local variations help in formation of wide variety of habitats.

122. Answer (4)

**Hint :** In an age pyramid if small number of pre-reproductive individuals are followed by a large number of reproductive individuals, it shows a declining growth.

**Sol. :** In urn shaped age pyramid small number of pre-reproductive individuals are followed by a large number of reproductive individuals. This population shows declining growth/negative growth.

123. Answer (1)

**Hint :** Exponential growth occurs when resources are unlimited.

**Sol. :** At the end of rainy season environmental resistance becomes effective suddenly and resources (food and space) become depleted which are responsible for decline in growth.

124. Answer (2)

**Sol. :** Integral form of the exponential growth equation is  $N_t = N_0 e^{rt}$ .

125. Answer (3)

**Hint :** Some organisms play role as predator in agricultural field.

**Sol. :** Due to the ability of predation some organisms are used to regulate prey population e.g. ladybird is useful in controlling aphids.

126. Answer (1)

**Hint :** Floc includes useful aerobic heterotrophic microbes in aeration tank.

**Sol. :** It is mass of bacteria associated with fungal filaments.

127. Answer (2)

**Sol. :** Ernst Chain and Howard Florey established penicillin as an effective antibiotic. They were awarded nobel prize in 1945.

128. Answer (1)

**Hint :** Somaclones are produced through a method of tissue culture, called micropropagation.

**Sol. :** Somaclones are produced by mitosis therefore they are genetically identical to the original plant from which they were grown.

129. Answer (4)

**Sol. :** Jaya and Ratna are semi dwarf varieties of rice.

130. Answer (1)

**Sol. :** Green revolution in India occurred during 1960s.

131. Answer (3)

**Hint :** Net population after time 't' can be expressed as

$$N_t = N_0 + [(B + I) - (D + E)]$$

$$N_0 = 200$$

$$B = 150$$

$$I = 50$$

$$D = 100$$

$$E = 20$$

$$N_t = ?$$

$$N_t = 200 + [(150 + 50) - (100 + 20)]$$

$$N_t = 200 + [200 - 120]$$

$$= 200 + 80$$

$$N_t = 280$$

132. Answer (2)

**Hint :** It is *Anabaena azollae*.

**Sol. :** *Anabaena* is a cyanobacterium.

133. Answer (1)

**Hint :** It is a bacterium.

**Sol. :** *Bacillus thuringiensis* is used to control butterfly caterpillars.

134. Answer (2)

**Sol. :** Tertiary sewage treatment is a physico chemical process.

135. Answer (3)

**Hint :** Yeast *Saccharomyces cerevisiae* is used in making bread and in production of alcohol.

**Sol. :** Yeast it is commonly known as baker's and brewer's yeast.

136. Answer (4)

**Hint :** MOET is not used in amphibians.

**Sol. :** Bony fishes and amphibians exhibit external fertilization, so the fertilized structure is not transferred into their body. MOET cannot be used in these cases due to external development of embryo.

137. Answer (1)

**Hint :** Antibody present in body fluids.

**Sol. :** Colostrum is a yellowish liquid substance that a nursing mother produces from her breasts 25-48 hours after delivery which is very important in the transfer of antibodies to the newborn.

138. Answer (3)

**Hint :** Smack is diacetylmorphine.

**Sol. :** Morphine is extracted from the latex of poppy plant *Papaver somniferum*. Heroin is obtained by acetylation of morphine (diacetyl morphine) commonly called smack which is a white, odourless and bitter crystalline compound. Generally, it is taken by snorting or injection. It is a depressant and slows down body functions.

139. Answer (2)

**Hint :** Type of breeding to obtain a pureline.

**Sol. :** Inbreeding increases homozygosity. Inbreeding is essential to evolve purelines in any animal and elimination of harmful recessive genes.

140. Answer (1)

**Hint :** Action of cyclosporin drug inhibits this immune response.

**Sol. :** Cell-mediated immune response comprising cytotoxic T cells (killer cells) is chiefly responsible for graft rejection.

141. Answer (1)

**Hint :** Hygienic conditions are required for good health.

**Sol. :** Awareness about disease and their effects on different bodily functions, vaccination (immunisation) against infectious diseases, proper disposal of wastes, control of vectors and maintenance of hygienic food and water resources are necessary for achieving good health.

142. Answer (2)

**Hint :** Disease caused by activation of proto oncogenes to oncogenes.

**Sol. :** Diseases which are easily transmitted from one person to another are called infectious diseases. Some of the infectious diseases like AIDS are fatal.

143. Answer (4)

**Hint :** Identify a viral disease.

**Sol. :** Dysentery, plague, diphtheria etc. are some of the bacterial diseases in man. Common cold is a viral disease.

144. Answer (4)

**Hint :** Pneumonia causing pathogens can be bacteria, viruses or fungi.

**Sol. :** In pneumonia, the alveoli get filled with fluid leading to severe problems in respiration. Symptoms of pneumonia include fever, chills, cough and headache.

145. Answer (2)

**Hint :** Disease spread by contaminated food and water.

**Sol. :** *Salmonella typhi* generally enters the small intestine through contaminated food and water and migrates to other organs through blood. In severe cases death may also occur.

146. Answer (3)

**Hint :** Identify the vector of malaria.

**Sol. :** *Plasmodium* multiplies within the body of female *Anopheles* to form sporozoites that reside in its salivary glands.

147. Answer (3)

**Hint :** Identify a toxic substance.

**Sol. :** Schizont has yellowish-brown pigment granules of haemozoin which is derived from the porphyrin part of haemoglobin in the red blood corpuscles.

148. Answer (4)

**Hint :** Identify the genus of pathogen causing typhoid.

**Sol. :** Many fungi belonging to the genera *Microsporum*, *Trichophyton* and *Epidermophyton* are responsible for ringworm.

149. Answer (3)

**Hint :** Identify a larvivorous fish.

**Sol. :** *Gambusia* feeds on mosquito larvae and helps control spread of vector borne diseases.

150. Answer (4)

**Hint :** Outbreeding can involve outcrossing, crossbreeding and interspecific hybridization.

**Sol. :** When breeding occurs between animals of same breed for 4-6 generations it is called inbreeding. A group of animals related by descent and similar in most characters like general appearance, features, size, configuration, etc., are said to belong to a breed.

151. Answer (3)

**Hint :** Identify the connecting link between living organisms and non-living entities.

**Sol. :** Interferons are glycoproteins synthesized in virus infected cells and affect neighbouring cells by synthesizing translation inhibitory proteins. Cancer patients are given biological response modifiers such as  $\alpha$ -interferons which activate their immune system and help in destroying the tumor.

152. Answer (1)

**Hint :** Elephantiasis is also called filariasis.

**Sol. :** Sleeping sickness is a protozoan disease and elephantiasis occurs due to helminthic infection. *Aedes* serves as vector for dengue and yellow fever.

153. Answer (3)

**Hint :** Preformed antibodies are transferred in passive immunity.

**Sol. :** When readymade antibodies are directly given to protect the body against a foreign agent, it is called passive immunity.

154. Answer (1)

**Hint :** HIV is a retro virus.

**Sol. :** Two identical single stranded RNA filaments are associated with reverse transcriptase in HIV.

155. Answer (1)

**Hint :** Identify a disease caused by a virus.

**Sol. :** Vector of chikungunya is a female *Aedes* mosquito.

156. Answer (4)

**Hint :** Membrane containing goblet cells.

**Sol. :** Mucus membrane lining the respiratory, gastrointestinal and urogenital tract are examples of physical barriers of innate immunity. Mucus helps in trapping the microbes entering our body.

157. Answer (4)

**Hint :** Acquired immunity develops due to antigenic stimulus.

**Sol. :** Acquired immunity is pathogen specific and anamnestic secondary response is characterized by prior encounter with antigen resulting in formation of memory cells during clonal selection.

158. Answer (3)

**Hint :** Antibody molecule is represented by  $H_2L_2$ .

**Sol. :** Each antibody is Y-shaped containing two light and two heavy chains connected with each other by disulphide bonds.

159. Answer (1)

**Hint :** N terminal of immunoglobulin has the antigen binding site.

**Sol. :** One end of the antibody binds to antigen (the  $F_{ab}$  portion, so called because it is the fragment of the molecule which is antigen binding or paratope), and the other end which is crystallisable and therefore called  $F_c$  which is responsible for effector function.

160. Answer (3)

**Hint :** Step taking place after antigen-antibody interaction.

**Sol. :** Neutralization is conversion of virulent into non-virulent form of pathogen. Lysis involves the rupture of plasma membrane of pathogen due to attack of antibody.

161. Answer (3)

**Hint :** Identify the disease which has been eradicated.

**Sol. :** First generation vaccines are whole organism vaccines, either live, weakened or killed.

Vaccine against typhoid, rabies, cholera, influenza and Salk polio vaccines are of killed type.

Small pox, OPV, BCG, influenza vaccines are attenuated.

162. Answer (2)

**Hint :** Organism that is used in fermentation.

**Sol. :** Vaccines produced using recombinant DNA technology allow large scale production and hence, greater availability for immunization.

163. Answer (1)

**Hint :** Disease caused by *Entamoeba histolytica*.

**Sol. :** *Entamoeba histolytica* is a protozoan parasite in the large intestine of humans which cause amoebiasis (amoebic dysentery).

164. Answer (3)

**Hint :** Identify the Ig found in low amounts in normal human body.

**Sol. :** IgE causes release of histamine from most cells. It also increases in number in parasitic infestations.

165. Answer (2)

**Hint :** Identify the main inflammatory mediator.

**Sol. :** Noradrenaline also quickly reduces the symptoms of allergy. Histamine is the main mediator of inflammation.

166. Answer (4)

**Hint :** Protected environment will lead to reduced development of acquired immunity.

**Sol. :** Protected environment in early life of children in metro cities decrease their immunity due to decrease in antigenic stimulus.

167. Answer (1)

**Hint :** Connective tissue which is present in bone for hemopoiesis.

**Sol. :** Secondary lymphoid structures are spleen, lymph nodes, tonsils, Peyer's patches of small intestine and appendix.

168. Answer (3)

**Hint :** Lobed structure which is located near the heart.

**Sol. :** Thymus and bone marrow are primary lymphoid organs, where immature lymphocytes differentiate into antigen sensitive lymphocytes.

169. Answer (4)

**Hint :** Graveyard of RBCs.

**Sol. :** Both bone marrow and thymus provide micro environment for the development and maturation of T-lymphocytes.

The secondary lymphoid organs provide the site for interaction of lymphocytes with antigens.

170. Answer (2)

**Hint. :** In human body, nearly half of lymphoid tissue is MALT.

**Sol. :** Lymphoid tissue which is located within the lining of the major tracts (respiratory, digestive and urogenital tracts) is called mucosa associated lymphoid tissue (MALT). It constitutes about 50% of the lymphoid tissue in human body.

171. Answer (1)

**Hint :** A disease present since birth.

**Sol. :** HIV causes deficiency of immune system, acquired during the life time of an individual indicating that it is not a congenital disease. HIV infection may be congenital.

172. Answer (2)

**Hint :** HIV is mainly present in blood and semen.

**Sol. :** Transmission of HIV generally occurs by transfusion of contaminated blood and blood products.

173. Answer (3)

**Hint :** Enzyme that catalyses reverse transcription.

**Sol. :** HIV consists of RNA genome with reverse transcriptase surrounded by protein coat. Reverse transcriptase can synthesize DNA from RNA.

174. Answer (4)

**Hint :** Adenoma is tumor of glands.

**Sol. :** Adenoma is a benign tumor of glands.

175. Answer (2)

**Hint :** The anthrone test is a highly sensitive test for fructose.

**Sol. :** Mantoux test is used for diagnosis of tuberculosis and Schick test for diphtheria.

176. Answer (3)

**Hint :** Commonly known as sadabahar.

**Sol. :** *Catharanthus roseus* is the source of anti-cancer drugs such as vinblastin and vincristin.

177. Answer (4)

**Hint :** Identify an arthropod.

**Sol. :** Marine water fishes are Bombay duck, Hilsa, Eel, Pomphret, Salmon and sardines which can be reared in pisciculture.

178. Answer (2)

**Hint. :** "A" represent analgesic.

**Sol. :** Natural cannabinoids are obtained from the inflorescence of *Cannabis sativa*. Morphine is extracted from the latex of *Papaver somniferum*.

179. Answer (4)

**Hint :** Present in beverages like wine.

**Sol. :** The chronic use of drugs and alcohol damage the nervous system and liver respectively.

180. Answer (2)

**Hint :** Jersey and Karan Fries are improved breeds of cattle.

**Sol. :** American breed of chickens include New Hampshire and Plymouth Rock.

Mediterranean breed of chicken is Leghorn.





## All India Aakash Test Series for NEET-2020

**TEST - 3 (Code-B)**

Test Date : 10/11/2019

**ANSWERS**

1. (3)	37. (1)	73. (3)	109. (4)	145. (1)
2. (1)	38. (2)	74. (2)	110. (2)	146. (2)
3. (2)	39. (4)	75. (4)	111. (1)	147. (4)
4. (2)	40. (1)	76. (3)	112. (4)	148. (3)
5. (1)	41. (3)	77. (1)	113. (2)	149. (1)
6. (3)	42. (3)	78. (2)	114. (3)	150. (4)
7. (4)	43. (1)	79. (4)	115. (1)	151. (2)
8. (4)	44. (3)	80. (4)	116. (4)	152. (3)
9. (2)	45. (1)	81. (1)	117. (3)	153. (1)
10. (1)	46. (2)	82. (3)	118. (2)	154. (2)
11. (4)	47. (3)	83. (3)	119. (2)	155. (3)
12. (3)	48. (4)	84. (2)	120. (2)	156. (3)
13. (1)	49. (1)	85. (1)	121. (1)	157. (1)
14. (2)	50. (2)	86. (3)	122. (3)	158. (3)
15. (3)	51. (2)	87. (1)	123. (2)	159. (4)
16. (2)	52. (3)	88. (2)	124. (4)	160. (4)
17. (3)	53. (4)	89. (3)	125. (1)	161. (1)
18. (4)	54. (1)	90. (1)	126. (2)	162. (1)
19. (3)	55. (2)	91. (3)	127. (3)	163. (3)
20. (1)	56. (4)	92. (2)	128. (3)	164. (1)
21. (4)	57. (3)	93. (1)	129. (2)	165. (3)
22. (3)	58. (3)	94. (2)	130. (3)	166. (4)
23. (1)	59. (1)	95. (3)	131. (3)	167. (3)
24. (3)	60. (3)	96. (1)	132. (4)	168. (4)
25. (2)	61. (2)	97. (4)	133. (4)	169. (3)
26. (4)	62. (1)	98. (1)	134. (1)	170. (3)
27. (4)	63. (3)	99. (2)	135. (2)	171. (2)
28. (3)	64. (3)	100. (1)	136. (2)	172. (4)
29. (3)	65. (1)	101. (3)	137. (4)	173. (4)
30. (1)	66. (4)	102. (2)	138. (2)	174. (2)
31. (3)	67. (1)	103. (1)	139. (4)	175. (1)
32. (3)	68. (2)	104. (4)	140. (3)	176. (1)
33. (1)	69. (3)	105. (3)	141. (2)	177. (2)
34. (4)	70. (3)	106. (2)	142. (4)	178. (3)
35. (3)	71. (1)	107. (1)	143. (3)	179. (1)
36. (4)	72. (2)	108. (3)	144. (2)	180. (4)

## HINTS & SOLUTIONS

### PHYSICS

1. Answer (3)

**Hint :**  $I_d = i_C = C \frac{dV}{dt}$

**Sol. :**  $I_d = C \frac{dV}{dt}$   
 $= 2 \times 10^{-6} \times 10^4$   
 $= 2 \times 10^{-2}$   
 $= 20 \text{ mA}$

2. Answer (1)

**Hint :**  $B = \frac{\mu_0 I}{2\pi R^2} r$

**Sol. :**  $B = \frac{4\pi \times 10^{-7} \times \pi \times 0.1}{2\pi \times \left(\frac{2}{10}\right)^2}$

$$B = \frac{2\pi \times 10^{-6}}{4}$$

$$B = 0.5\pi \times 10^{-6}$$

$$B = 5\pi \times 10^{-7} \text{ T}$$

3. Answer (2)

**Hint :**  $B_0 = \mu_0 H_0$

**Sol. :**  $B_0 = \frac{E_0}{c}$

$$\frac{E_0}{c} = \mu_0 H_0$$

$$\sqrt{\mu_0 \epsilon_0} E_0 = \mu_0 H_0$$

$$H_0 = E_0 \sqrt{\frac{\epsilon_0}{\mu_0}}$$

4. Answer (2)

**Hint :**  $\Delta p = \frac{Pt}{c}$

**Sol. :**  $p_f - p_i = \frac{20 \times 10^{-3} \times 6 \times 10^{-9}}{3 \times 10^8}$

$$P_f = 40 \times 10^{-20}$$

$$P_f = 4.0 \times 10^{-19} \text{ kg m/s}$$

5. Answer (1)

**Hint and Sol. :** Direction of propagation of EM wave will be in the direction of  $\vec{E} \times \vec{B}$  therefore direction of propagation will be perpendicular to both  $\vec{E}$  and  $\vec{B}$ .

6. Answer (3)

**Hint :**  $I = \frac{V}{Z}$

**Sol. :** When L is removed

$$\tan \phi_1 = \frac{X_C}{R}$$

When C is removed

$$\tan \phi_2 = \frac{X_L}{R}$$

Given  $\phi_1 = \phi_2$

$$\frac{X_L}{R} = \frac{X_C}{R}$$

$X_L = X_C$  this is the condition of resonance

So,  $Z = R$

$$I = \frac{V}{R}$$

$$I = \frac{100}{50}$$

$I = 2 \text{ A}$

7. Answer (4)

**Hint :**  $X_C = \frac{1}{\omega C}$

**Sol. :**  $R = \frac{V^2}{P}$

$$R = \frac{(100)^2}{100}$$

$R = 100 \Omega$

$P = VI$

$$I = \frac{100}{100}$$

$I = 1 \text{ A}$

Current in the circuit without capacitor

$$I = \frac{V}{R}$$

$$I = \frac{200}{100}$$

$I = 2 \text{ A}$

To reduce the current 1 A capacitor can be added.

$$I = \frac{V}{\sqrt{R^2 + (X_C)^2}}$$

$$I = \frac{200}{\sqrt{(100)^2 + (X_C)^2}}$$

$$(100)^2 + X_C^2 = (200)^2$$

$$X_C^2 = 40000 - 10000$$

$$X_C = \sqrt{3} \times 100$$

$$\frac{1}{\omega C} = \sqrt{3} \times 100$$

$$C = \frac{1}{100\pi \times \sqrt{3} \times 100}$$

$$C = 18 \mu\text{F}$$

8. Answer (4)

**Hint :**  $E_p = \frac{-d\phi_P}{dt}$  and  $\frac{E_S}{E_P} = \frac{N_S}{N_P}$

**Sol. :**  $E_p = -500 \frac{d}{dt}(2+2t)$   
 $= -1000 \text{ V}$   
 $|E_p| = 1000 \text{ V}$

$$\frac{E_s}{E_p} = \frac{N_s}{N_p}$$

$$E_s = \frac{1000}{500} \times 1000$$

$$E_s = 2000 \text{ V}$$

9. Answer (2)

**Hint :** At any time(t) voltage drop across the capacitor plus voltage drop across the inductor will be zero.

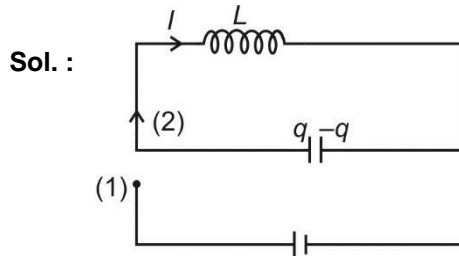

$$V_L + V_C = 0$$

$$-L \frac{dI}{dt} + V_C = 0$$

$$I = -\frac{dq}{dt}$$

$$L \frac{d^2q}{dt^2} + \frac{q}{C} = 0$$

$$\frac{d^2q}{dt^2} + \frac{q}{LC} = 0$$

10. Answer (1)

**Hint and Sol. :** A choke coil has high inductance and low resistance.

11. Answer (4)

**Hint :** Voltage across inductor leads the current.

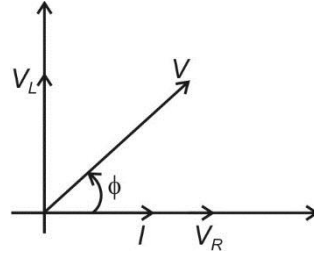

**Sol. :**

$$X_L = \omega L$$

$$= 200 \times 100 \times 10^{-3}$$

$$= 20 \Omega$$

$$\tan \phi = \frac{V_L}{V_R} = \frac{X_L}{R} = \frac{20}{20} = 1$$

$$\phi = \frac{\pi}{4}$$

12. Answer (3)

**Hint :**  $I_{r.m.s} = \sqrt{\frac{\int I^2 dt}{\int dt}}$

**Sol. :**  $I_{r.m.s} = \sqrt{\frac{\int I^2 dt}{\int dt}}$

$$I_{m.s} = \frac{\int_0^T (3t^2)^2 dt}{\int_0^T dt}$$

$$= \frac{9 \int_0^T t^4 dt}{T}$$

$$= \frac{9}{5} T^4$$

$$I_{r.m.s} = \sqrt{I_{m.s}}$$

$$= \frac{3}{\sqrt{5}} T^2$$

13. Answer (1)

**Hint :**  $I = \frac{V}{Z}$ ,  $V_C = IX_C$

**Sol. :**  $Z = \sqrt{R^2 + (X_C - X_L)^2}$

$$Z = \sqrt{(40)^2 + (50 - 20)^2}$$

$$= 50 \Omega$$

$$I = \frac{250}{50}$$

$$I = 5 \text{ A}$$

$$V_C = IX_C$$

$$= 5 \times 50$$

$$V_C = 250 \text{ V}$$

14. Answer (2)

**Hint :** Power factor  $\cos\phi = \frac{R}{Z}$ 

$$\begin{aligned}\text{Sol. : } Z &= \sqrt{R^2 + (X_c)^2} \\ &= \sqrt{R^2 + \left(\frac{1}{\omega C}\right)^2} \\ \cos\phi &= \frac{R}{\sqrt{R^2 + \left(\frac{1}{\omega C}\right)^2}} \\ &= \frac{R\omega C}{\sqrt{(R\omega C)^2 + 1}}\end{aligned}$$

15. Answer (3)

**Hint :**  $\mu = \tan i_p$ 

$$\text{Sol. : } \sin i_c = \frac{1}{\mu}$$

$$\frac{1}{\mu} = \sin 60^\circ$$

$$\mu = \frac{2}{\sqrt{3}}$$

$$i_p = \tan^{-1}\left(\frac{2}{\sqrt{3}}\right)$$

16. Answer (2)

**Hint and Sol. :** The synthetic material used for the preparation of polaroids possess the property of dichroism.

17. Answer (3)

**Hint :**  $I_1 = I \cos^2\phi$ **Sol. :** After rotating  $30^\circ$  angle between axes of two polaroids becomes  $60^\circ$ .

$$I = \frac{I_0}{2} \cos^2 60^\circ$$

$$I = \frac{I_0}{8}$$

$$\%I = \frac{I}{I_0} \times 100$$

$$= \frac{1}{8} \times 100$$

$$= 12.5\%$$

18. Answer (4)

**Hint :** Between two first minima on either side central maxima will form.

$$\text{Sol. : } W = \frac{2\lambda D}{d}$$

$$W = \frac{2 \times 400 \times 10^{-9} \times 2}{2 \times 10^{-3}}$$

$$W = 8 \times 10^{-4}$$

$$W = 800 \times 10^{-6}$$

$$W = 800 \mu\text{m}$$

19. Answer (3)

**Hint :** Resolving power  $\propto \frac{1}{\lambda}$ 

$$\text{Sol. : } \frac{R \cdot P_1}{R \cdot P_2} = \frac{\lambda_2}{\lambda_1} = \frac{6000 \text{ \AA}}{4500 \text{ \AA}} = \frac{4}{3}$$

20. Answer (1)

**Hint :** When light wave travels from one medium to another medium wavelength of light will change while frequency remains same.**Sol. :**  $v_1 = v$ 

$$\lambda_1 = \frac{\lambda}{\mu}$$

$$= \frac{\lambda}{4}$$

$$= \frac{3\lambda}{4}$$

21. Answer (4)

**Hint and Sol. :** Huygen's principle is used to prove the laws of reflection and refraction.

22. Answer (3)

**Hint and Sol. :** The amount of bending of light depend upon the size of the obstacle and wavelength of light used.

23. Answer (1)

$$\text{Hint : } L = \frac{N\lambda_0 D}{\mu d}$$

$$\text{Sol. : } L = \frac{N\lambda_0 D}{\mu d}$$

$$N = \mu \frac{Ld}{\lambda_0 D}$$

$$N \propto \mu$$

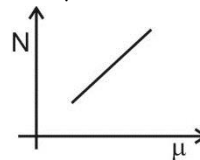

24. Answer (3)

**Hint :** For maxima  $x = \frac{n\lambda D}{d}$ For minima  $x = \frac{(2n+1)\lambda D}{2d}$ ,  $n = 0, 1, 2, \dots$ 

$$\text{Sol. : } x_{2B} = \frac{2\lambda D}{d}$$

$$x_{5D} = \frac{9\lambda D}{2d}$$

$$x_{5D} - x_{2B} = \frac{5\lambda D}{2d}$$

$$5 \times 10^{-3} = \frac{5}{2} \times \frac{100 \times 10^{-2}}{0.3 \times 10^{-3}} \times \lambda$$

$$\lambda = 6 \times 10^{-7}$$

$$\lambda = 600 \times 10^{-9}$$

$$\lambda = 600 \text{ nm}$$

25. Answer (2)

**Hint :**  $I_R = I_1 + I_2 + 2\sqrt{I_1 \times I_2} \cos \phi$ ,  $\frac{I_1}{I_2} = \frac{b_1}{b_2}$

**Sol. :**  $I_{\max} = I + 4I + 2 \times 2I$

$I_0 = I_{\max} = 9I$

$I = \left(\frac{I_0}{9}\right)$

At  $\phi = 60$

$I_R = I + 4I + 4I \times \frac{1}{2}$

$I_R = 7I$

$I_R = \frac{7I_0}{9}$

26. Answer (4)

**Hint :** Use  $\frac{1}{f} = \frac{1}{f_1} + \frac{1}{f_2}$

**Sol. :**  $\frac{f_{\text{convex}}}{f_{\text{concave}}} = \frac{2}{3}$

$\frac{1}{f} = \frac{1}{f_{\text{convex}}} + \frac{1}{f_{\text{concave}}}$

$\frac{1}{30} = \frac{1}{f_{\text{convex}}} - \frac{1}{\frac{3}{2}f_{\text{convex}}}$

$\frac{1}{30} = \frac{1}{f_{\text{convex}}} - \frac{2}{3f_{\text{convex}}}$

$\frac{1}{30} = \frac{1}{3f_{\text{convex}}}$

$f_{\text{convex}} = 10 \text{ cm}$

$f_{\text{concave}} = -\frac{3}{2}f_{\text{convex}}$

$= -\frac{3}{2} \times 10$

$= -15 \text{ cm}$

27. Answer (4)

**Hint :** Use Snell's law

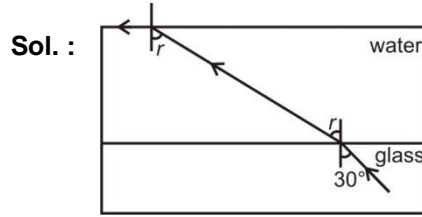

**Sol. :**

At glass water interface

$\frac{\sin 30^\circ}{\sin r} = \frac{\mu_w}{\mu_g}$  ... (i)

At water air interface

$\sin r = \frac{1}{\mu_w}$  ... (ii)

Equation (i) and (ii)

$\sin 30^\circ = \frac{1}{\mu_g}$

$\frac{1}{2} = \frac{1}{\mu_g}$

$\mu_g = 2$

28. Answer (3)

**Hint :** The image of an object at 25 cm, should form at 50 cm.

**Sol. :**  $u = -25 \text{ cm}$

$v = -50 \text{ cm}$

$\frac{1}{f} = \frac{1}{v} - \frac{1}{u}$

$\frac{1}{f} = \frac{1}{-50} + \frac{1}{25}$

$f = 50 \text{ cm (convex lens)}$

29. Answer (3)

**Hint and Sol. :** Total internal reflection is used in optical fiber for transmission of light energy.

30. Answer (1)

**Hint :**  $m = -\frac{v}{u}$  and

$\frac{1}{v} + \frac{1}{u} = \frac{1}{f}$

**Sol. :**  $\frac{1}{f} = \frac{1}{v} + \frac{1}{u}$

$\frac{1}{-20} = \frac{1}{v} - \frac{1}{30}$

$\frac{1}{v} = -\frac{1}{20} + \frac{1}{30}$

$= \frac{-3+2}{60}$

$v = -60 \text{ cm}$

$m = -\frac{60}{30} = -2$

31. Answer (3)

Hint :  $v_{I_x} = mv_{O_x}$

$$v_{I_y} = -m^2 v_{O_y}$$

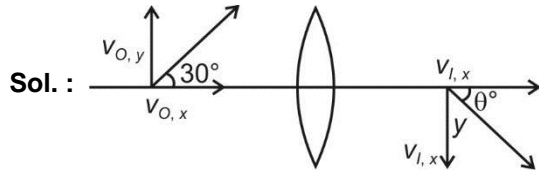

At  $x = 30 \text{ cm}$

$$m = 1$$

$$v_{I_x} = v_{O_x}$$

$$v_{I_y} = v_{O_y}$$

$$\tan \theta = -\frac{v_{O_y}}{v_{O_x}}$$

$$\tan \theta = -\tan 30^\circ$$

$$\theta = -30^\circ$$

32. Answer (3)

Hint and Sol. :

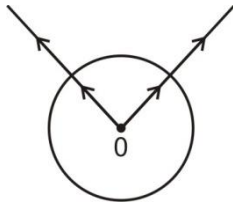

The rays from the object fall normally on the surface of sphere and emerge undeviated. When drawn backwards, they will meet at O. The image will form at center itself.

33. Answer (1)

Hint : Ray will be undeviated if incident ray and emergent ray will be parallel to each other.

Sol. : Incident rays and emergent rays will be parallel if refracted rays from convex lens meet at the focus of concave lens.

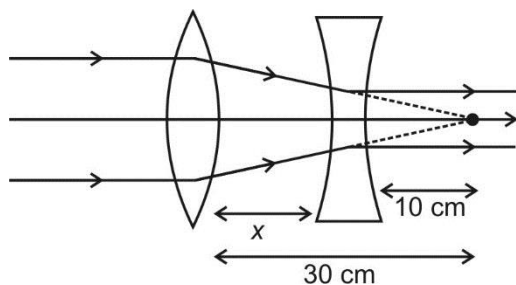

$$x = 30 - 10$$

$$x = 20 \text{ cm}$$

34. Answer (4)

Hint and Sol. : Total internal reflection will occur if ray travel from denser to rarer medium. Let refractive index of medium A, B and C are  $\mu_1$ ,  $\mu_2$  and  $\mu_3$  respectively

$$\mu_1 > \mu_2 > \mu_3$$

$$C_1 < C_2 < C_3$$

35. Answer (3)

Hint : Magnification will be minimum when image will formed at infinity.

$$\text{Sol. : } M = \frac{v_0 D}{u_0 f_e}$$

$$M' = \frac{v_0 D}{u_0 \left(\frac{f_e}{2}\right)}$$

$$= 2M$$

36. Answer (4)

Hint : Image formed by both plane mirror and convex mirror at same point

Sol. :

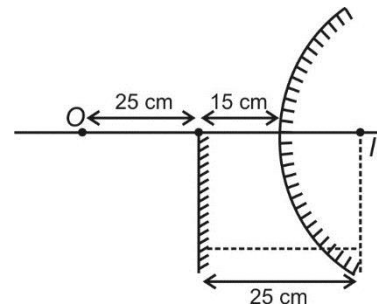

Image formed by plane mirror will be at distance of 25 cm from plane mirror and 10 cm from the pole of convex mirror. By mirror formula.

$$\frac{1}{v} + \frac{1}{u} = \frac{1}{f}$$

$$\frac{1}{+10} - \frac{1}{40} = \frac{1}{f}$$

$$\frac{4-1}{40} = \frac{1}{f}$$

$$f = \frac{40}{3} \text{ cm}$$

$$R = 2f$$

$$= \frac{80}{3} \text{ cm}$$

37. Answer (1)

Hint : Use  $\frac{1}{v} + \frac{1}{u} = \frac{1}{f}$  and  $m = -\frac{v}{u}$

**Sol. :** For virtual image

$$m = -\frac{v}{u} = \frac{l}{O}$$

$$v = -2u$$

$$\frac{1}{v} + \frac{1}{u} = \frac{1}{f}$$

$$\frac{1}{-2u} + \frac{1}{u} = -\frac{1}{10}$$

$$\frac{1}{2u} = -\frac{1}{10}$$

$$u = -5 \text{ cm}$$

For real image

$$\frac{1}{v} + \frac{1}{u} = \frac{1}{f}$$

$$\frac{1}{2u} + \frac{1}{u} = -\frac{1}{10}$$

$$\frac{3}{2u} = -\frac{1}{10}$$

$$u = -15 \text{ cm}$$

$$x = |-15| - |-5| = 10 \text{ cm}$$

38. Answer (2)

**Hint :** Apply Snell's law and prism formula.

$$\text{Sol. : } \frac{\mu_2}{\mu_1} = \frac{\sin i}{\sin(r)}$$

for minimum deviation

$$i = \frac{A + \delta_m}{2}$$

$$r = \frac{A}{2}$$

$$\frac{3}{\sqrt{3}} = \frac{\sin\left(\frac{60^\circ + \delta_m}{2}\right)}{\sin 30^\circ}$$

$$\frac{\sqrt{3}}{2} = \sin\left(\frac{60^\circ + \delta_m}{2}\right)$$

$$\frac{60^\circ + \delta_m}{2} = 60^\circ$$

$$\delta_m = 60^\circ$$

39. Answer (4)

$$\text{Hint : } \frac{\mu_1}{f} = (\mu_2 - \mu_1) \left( \frac{1}{R_1} - \frac{1}{R_2} \right)$$

**Sol. :** In air

$$\frac{1}{f} = \left( \frac{4}{3} - 1 \right) \left( \frac{1}{R_1} - \frac{1}{R_2} \right)$$

In glass

$$\frac{3}{2} = \left( \frac{4}{3} - \frac{3}{2} \right) \left( \frac{1}{R_1} - \frac{1}{R_2} \right)$$

$$\frac{3}{2f_1} = \left( \frac{4}{3} - \frac{3}{2} \right) \left( \frac{1}{R_1} - \frac{1}{R_2} \right)$$

$$\frac{3f}{2f_1} = -\frac{1}{2}$$

$$f_1 = -3f$$

Focal length becomes  $3f$  and nature will be diverging.

40. Answer (1)

**Hint :** Lateral displacement by parallel faced slab.

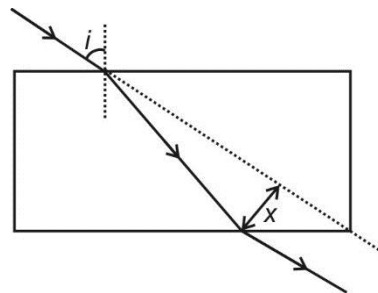

**Sol. :**

$$x = \frac{t \sin(i - r)}{\cos r}$$

$$5 = 5 \frac{\sin(i - r)}{\cos r}$$

$$\cos r = \sin(i - r)$$

$$\sin(90^\circ - r) = \sin(i - r)$$

$$90^\circ - r = i - r$$

$$i = 90^\circ$$

41. Answer (3)

$$\text{Hint : Dispersive power} = \frac{\mu_V - \mu_R}{\mu_Y - 1}$$

$$\text{Sol. : } \omega = \frac{1.704 - 1.690}{1.694 - 1}$$

$$= \frac{0.014}{0.694}$$

$$\approx 0.02017$$

$$\approx 0.020$$

42. Answer (3)

**Hint :** For normal adjustment length of the tube

$$L = f_e + f_o$$

**Sol. :**  $m = \frac{f_0}{f_e}$

$$15 = \frac{f_0}{f_e}$$

$$f_0 = 15f_e$$

$$80 = f_e + 15f_e$$

$$f_e = 5 \text{ cm}$$

$$80 = 5 + f_0$$

$$f_0 = 75 \text{ cm}$$

43. Answer (1)

**Hint and Sol. :** Lens Maker's formula is applicable to thin lenses and paraxial rays which subtend very small angle with principle axis.

44. Answer (3)

**Hint :** Use Snell's law

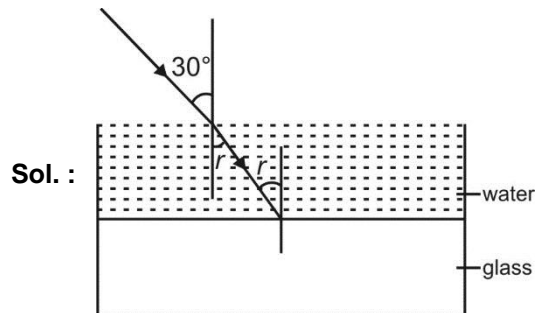

$$\frac{\sin 30^\circ}{\sin r} = \frac{\mu_w}{\mu_a}$$

$$\frac{1}{2 \sin r} = \frac{4}{3}$$

$$\sin r = \frac{3}{8}$$

$$r = \sin^{-1}\left(\frac{3}{8}\right)$$

45. Answer (1)

**Hint :**  $\vec{v}_{IO} = \vec{v}_{IM} - \vec{v}_{OM}$

$$\vec{v}_{OM} = (4\hat{i} + 4\hat{j}) \text{ m/s}$$

$$\vec{v}_{IM} = (-4\hat{i} + 4\hat{j}) \text{ m/s}$$

$$\vec{v}_{IO} = (-4\hat{i} + 4\hat{j}) - (4\hat{i} + 4\hat{j})$$

$$\vec{v}_{IO} = -8\hat{i} \text{ m/s}$$

## CHEMISTRY

46. Answer (2)

**Hint :** Victor Meyer test is done to distinguish primary, secondary and tertiary alcohols.

**Sol. :** Secondary alcohols give blue colouration in this test.

47. Answer (3)

**Hint:** Enantiomers are non-superimposable mirror images.

48. Answer (4)

**Hint:**  $R-X + R^1O^-Na^+ \rightarrow R-OR^1 + NaX$

In this reaction R cannot be vinylic or a 3° alkyl group.

49. Answer (1)

**Hint:**

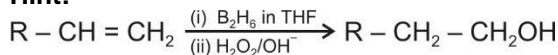

This is called hydroboration-oxidation reaction.

50. Answer (2)

**Hint:** A is a hydroperoxide.

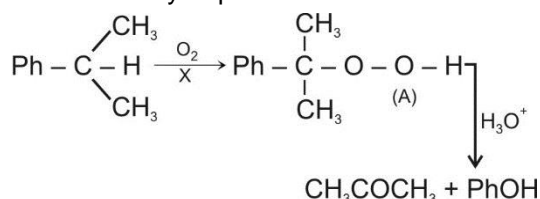

51. Answer (2)

**Hint:**

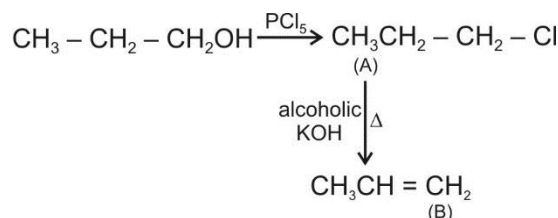

52. Answer (3)

**Hint:**  $\text{ZnCl}_2/\text{HCl}$  is Lucas reagent.

**Sol. :** Lucas reagent reacts fastest with tertiary alcohol.

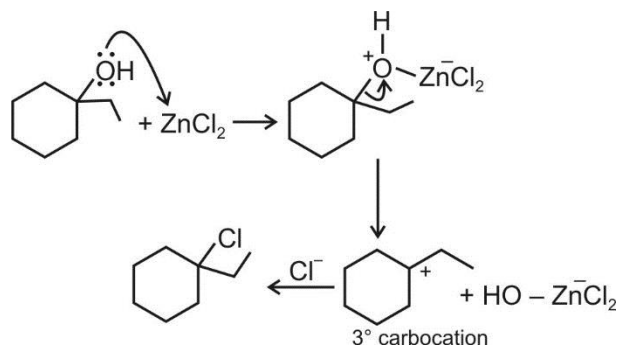

53. Answer (4)

**Hint:** Order of acidic strength

Phenol > Alcohols

54. Answer (1)

**Hint :** Grignard reagent on reaction with formaldehyde followed by hydrolysis gives primary alcohol.



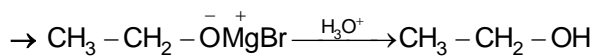
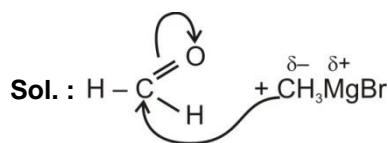

55. Answer (2)

**Hint:** Reactions in which O - H bond of R - OH molecule is broken, exhibits acidic nature.

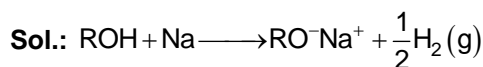

56. Answer (4)

**Hint :** Cleavage of ether by  $\text{S}_{\text{N}}2$  mechanism.

Sol. :

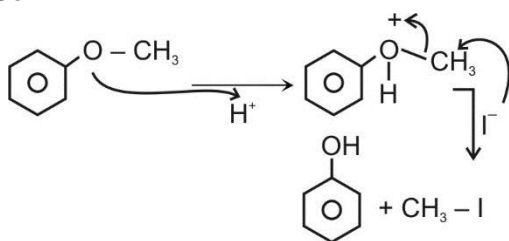

57. Answer (3)

**Hint :**  $\text{CCl}_2$  intermediate is formed in Reimer Tiemann reaction.



58. Answer (3)

**Hint :** Acetylide ion is a good nucleophile.

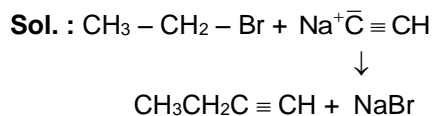

59. Answer (1)

**Hint :** Gem-diols are unstable molecules.

Sol. :

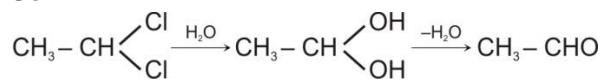

60. Answer (3)

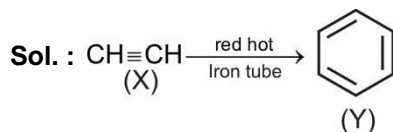
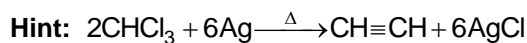

61. Answer (2)

**Hint:** Phenol contains acidic hydrogen.

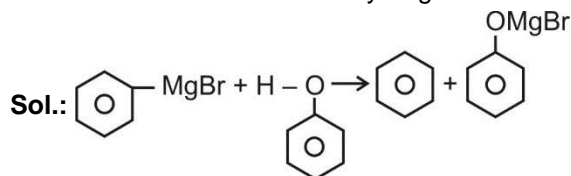

62. Answer (1)

**Hint :** C - X bond has partial double bond character in vinyl bromide and bromobenzene.

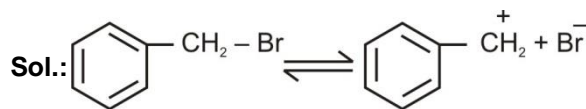

Stable cation

Also since C - Br bond is weaker than C - Cl bond, so C - Br bond is weakest in benzyl bromide.

63. Answer (3)

**Hint:** Preparation of alkyl benzene from aryl halide and alkyl halide using Na/dry ether is known as Wurtz-Fittig reaction.

64. Answer (3)

**Hint:** Boiling point  $\propto$  Surface area.

Sol. : Primary alkyl group has larger surface area than that of isomeric secondary and tertiary alkyl groups.

65. Answer (1)

**Hint:** Swarts reaction

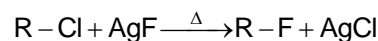

66. Answer (4)

**Hint :** The reaction follows benzyne mechanism.

Sol. :

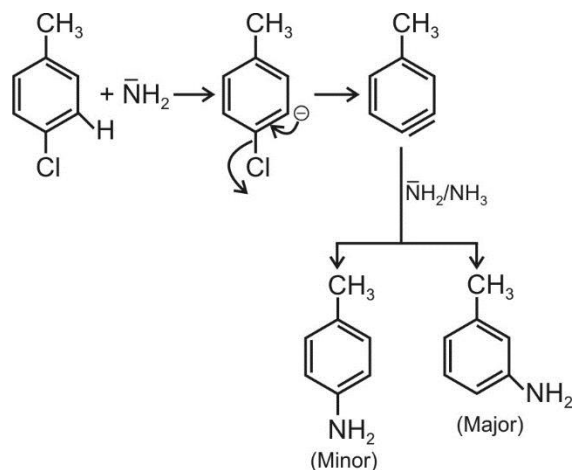

67. Answer (1)

**Hint:** Dipole moment = Charge  $\times$  bond length

Sol.: Since C - Cl bond length  $>$  C - F bond length

$\therefore$   $\text{CH}_3\text{Cl}$  has greater dipole moment than that of  $\text{CH}_3\text{F}$ .

68. Answer (2)

**Hint:** Rate of  $\text{S}_{\text{N}}1$  reaction  $\propto$  Stability of carbocation

**Sol.:** Relative stabilities of carbocation is

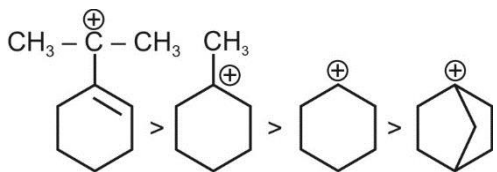

Bridgehead carbocation is least stable.

69. Answer (3)

**Hint:** Vinylic carbocation is highly unstable.

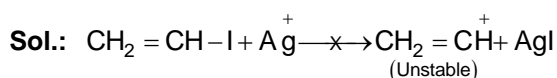

Hence yellow AgI ppt. is not obtained in this case.

70. Answer (3)

**Hint :** Fluoroalkanes undergo elimination via  $\text{E}_{1\text{cB}}$  mechanism.

**Sol. :**

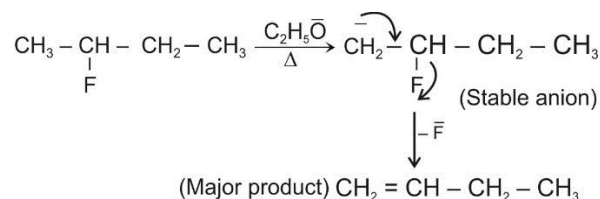

71. Answer (1)

**Hint:** Weak field ligand complexes are generally high spin and outer orbital.

**Sol.:** In  $[\text{CoF}_6]^{3-}$ ,  $\text{Co}^{3+}$  ion has  $3d^6$  configuration and since  $\text{F}^-$  is a weak field ligand hence it acquires  $sp^3d^2$  hybridisation and is outer orbital complex.

72. Answer (2)

**Hint :**  $\text{NO}_2^-$  is an ambidentate ligand.

$\text{NO}_2^-$  can be bonded through either N atom or O atom.

73. Answer (3)

**Hint:** Square planar complex  $[\text{Mabcd}]$  has three geometrical isomers as ligand a may have b, c or d to its trans position.

74. Answer (2)

**Hint:** Ziegler Natta catalyst :  $\text{TiCl}_4 + (\text{C}_2\text{H}_5)_3\text{Al}$ .

75. Answer (4)

**Hint :** More the charge density on central metal and more the chelation, more will be  $\Delta_0$ .

76. Answer (3)

**Hint :** In tetrahedral complex, splitting is lesser as compared to octahedral field splitting.

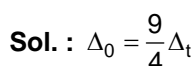

77. Answer (1)

**Hint:** Primary valency is equal to the oxidation number of the metal in complex.

**Sol.:** In  $[\text{Ni}(\text{CO})_4]$  oxidation number of Ni is zero.

78. Answer (2)

**Hint :**  $\text{EAN} = \text{Z} - \text{O. S.} + 2 \times \text{C.N.}$

**Sol. :** EAN of Cr =  $24 - 3 + 2 \times 6 = 33$

79. Answer (4)

**Hint :**

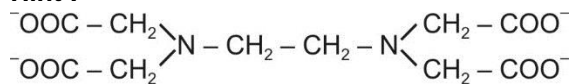

**Sol. :** EDTA can donate maximum 6 electron pairs, so its maximum number of coordination sites is 6.

80. Answer (4)

**Hint:** Lanthanoid hydroxides are less basic than alkali metal hydroxides.

81. Answer (1)

**Hint:**  $\text{Ti}^{4+}$  has  $d^0$  configuration, hence colourless.

82. Answer (3)

**Hint:** Mn shows +2 to +7 oxidation states.

83. Answer (3)

**Hint:**

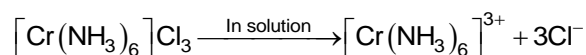

So, 3 moles of AgCl will be precipitated.

84. Answer (2)

**Hint:** Acidified  $\text{K}_2\text{Cr}_2\text{O}_7$  oxidises sulphides into sulphur.

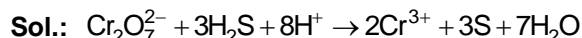

85. Answer (1)

**Hint:**  $\mu = \sqrt{n(n+2)}$  BM

**Sol.:**  $\mu = \sqrt{n(n+2)}$  BM = 5.916 BM

$\therefore n = 5$

For, Fe(26) :  $[\text{Ar}]3d^64s^2$

$\text{Fe}^{3+}$  :  $[\text{Ar}]3d^5$  has 5 unpaired electrons

86. Answer (3)

**Hint:**  $E = \frac{M}{n - \text{factor}}$

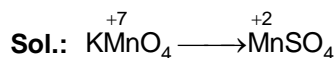

$\therefore n \text{ factor} = 5$ , hence,  $E = M/5$

87. Answer (1)

**Hint:** In lower oxidation state of metal, oxides show more basic character.

88. Answer (2)

**Hint:**

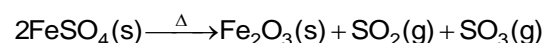

89. Answer (3)  
**Hint:**  $d^0$  and  $d^{10}$  configurations do not involve d-d transition.  
**Sol.:** In purple coloured  $MnO_4^-$ , Mn has no d electron. So, d-d transition is not possible. All other three ions are coloured due to d-d transition.  $MnO_4^-$  shows colour due to charge transfer
90. Answer (1)  
**Hint :** Brass contains copper and zinc.

### BIOLOGY

91. Answer (3)  
**Hint :** Yeast *Saccharomyces cerevisiae* is used in making bread and in production of alcohol.  
**Sol. :** Yeast it is commonly known as baker's and brewer's yeast.
92. Answer (2)  
**Sol. :** Tertiary sewage treatment is a physico chemical process.
93. Answer (1)  
**Hint :** It is a bacterium.  
**Sol. :** *Bacillus thuringiensis* is used to control butterfly caterpillars.
94. Answer (2)  
**Hint :** It is *Anabaena azollae*.  
**Sol. :** *Anabaena* is a cyanobacterium.
95. Answer (3)  
**Hint :** Net population after time 't' can be expressed as  

$$N_t = N_0 + [(B + I) - (D + E)]$$

$$N_0 = 200$$

$$B = 150$$

$$I = 50$$

$$D = 100$$

$$E = 20$$

$$N_t = ?$$

$$N_t = 200 + [(150 + 50) - (100 + 20)]$$

$$N_t = 200 + [200 - 120]$$

$$= 200 + 80$$

$$N_t = 280$$
96. Answer (1)  
**Sol. :** Green revolution in India occurred during 1960s.
97. Answer (4)  
**Sol. :** Jaya and Ratna are semi dwarf varieties of rice.

98. Answer (1)  
**Hint :** Somaclones are produced through a method of tissue culture, called micropropagation.  
**Sol. :** Somaclones are produced by mitosis therefore they are genetically identical to the original plant from which they were grown.
99. Answer (2)  
**Sol. :** Ernst Chain and Howard Florey established penicillin as an effective antibiotic. They were awarded nobel prize in 1945.
100. Answer (1)  
**Hint :** Floc includes useful aerobic heterotrophic microbes in aeration tank.  
**Sol. :** It is mass of bacteria associated with fungal filaments.
101. Answer (3)  
**Hint :** Some organisms play role as predator in agricultural field.  
**Sol. :** Due to the ability of predation some organisms are used to regulate prey population e.g. ladybird is useful in controlling aphids.
102. Answer (2)  
**Sol. :** Integral form of the exponential growth equation is  $N_t = N_0 e^{rt}$ .
103. Answer (1)  
**Hint :** Exponential growth occurs when resources are unlimited.  
**Sol. :** At the end of rainy season environmental resistance becomes effective suddenly and resources (food and space) become depleted which are responsible for decline in growth.
104. Answer (4)  
**Hint :** In an age pyramid if small number of pre-reproductive individuals are followed by a large number of reproductive individuals, it shows a declining growth.  
**Sol. :** In urn shaped age pyramid small number of pre-reproductive individuals are followed by a large number of reproductive individuals. This population shows declining growth/negative growth.
105. Answer (3)  
**Hint :** Desert lizards lack physiological ability to cope with extreme temperature. They manage body temperature by behavioural means.  
**Sol. :** Ozone layer of stratosphere absorbs UV-C and half of the UV-B radiations.  
 Vegetation in any area is determined by soil composition and topography.  
 In a biome, regional and local variations help in formation of wide variety of habitats.

106. Answer (2)

**Sol. :** The salt concentration (in parts per thousand) of sea water may range between 30-35.

107. Answer (1)

**Hint :** Hypersaline and hyposaline terms are used to measure salt concentration of water bodies.

**Sol. :** Organisms which are restricted to a narrow range of salinities are called stenohaline.

108. Answer (3)

**Hint :** *Oscillatoria* and *Aulosira* are cyanobacteria.

**Sol. :** These cyanobacteria (BGA) can fix nitrogen, thus increase soil fertility. *Rhizobium* is a symbiotic  $N_2$ -fixing bacteria but *Propionibacterium sharmanii* bacterium is used in Swiss cheese production.

109. Answer (4)

**Sol. :** In India, technology of biogas production was mainly developed by the efforts of Indian Agriculture Research Institute (IARI) and Khadi and Village Industries Commission (KVIC).

110. Answer (2)

**Hint :** BOD is the amount of oxygen that would be consumed if all the organic matter in one litre of water is oxidised by bacteria.

**Sol. :** If more is the organic matter in sewage water more will be the BOD. Thus, BOD is the indirect measure of the organic matter present in water.

111. Answer (1)

**Sol. :** Mixture of gases such as  $CH_4$ ,  $H_2S$  and  $CO_2$  is produced by bacteria in anaerobic sludge digester.

112. Answer (4)

**Sol. :** *Azotobacter* is a free living  $N_2$ -fixing bacteria in soil.

113. Answer (2)

**Hint :** Large and small particles are removed from sewage by physical treatment.

**Sol. :** Primary sewage treatment is physical treatment. It includes filtration and sedimentation.

114. Answer (3)

**Hint :** This vitamin is chemically known as cyanocobalamin.

**Sol. :** Curd contains number of vitamins especially  $B_{12}$ .

115. Answer (1)

**Sol. :** Wheat variety Atlas 66 has high protein content.

116. Answer (4)

**Sol. :** Breeding of crops with higher levels of vitamins and minerals or higher protein and healthier fats is called biofortification. It does not include improvement of carbohydrate quality.

117. Answer (3)

**Hint :** Per capita death is death rate.

**Sol. :** An individual may have birth and death but birth and death rates and sex ratio are characteristics of population not of an organism. Hence, birth rates, death rates and sex ratio are population attributes.

118. Answer (2)

**Sol. :** Keolado National Park is situated in Bharatpur (Rajasthan).

119. Answer (2)

**Hint :** Eurythermals are not restricted to narrow range of temperatures.

**Sol. :** They can tolerate and grow well in a wide range of temperature.

120. Answer (2)

**Hint :** Population is number of individuals of a species in a particular area.

**Sol. :** Population includes number of individuals of different ages. Plotting of age distribution for a population is called an age pyramid.

121. Answer (1)

**Sol. :** According to Allen's rule, mammals from colder climates generally have shorter ears and limbs to minimise heat loss.

122. Answer (3)

**Hint :** Conformers are not able to maintain homeostasis.

**Sol. :** Maintenance of constancy of internal environment is called homeostasis. 99% animals and nearly all plants are conformers.

123. Answer (2)

**Sol. :** Lipases are obtained from yeast *Candida lipolytica* and *Geotrichum candidum*.

124. Answer (4)

**Hint :** Cyclosporin-A is used during organ-transplant.

**Sol. :** It is used as immunosuppressive agent.

125. Answer (1)

**Hint :** LAB (Lactic Acid Bacteria) play beneficial role in our stomach.

**Sol. :** LAB improve nutritional quality of curd by increasing vit- $B_{12}$ . Besides this they play beneficial role in checking disease causing microbes in our stomach.

Rest of the statements are true.

126. Answer (2)

**Sol. :**

- a. Totipotency – It is capacity to generate whole plant from any cell  
 b. SCP – *Spirulina*  
 c. Explant – Plant part which is cultured  
 d. Callus – It is unorganised mass of cells in culture medium.

127. Answer (3)

**Hint :** It is a tissue which has cells in continuous state of division.**Sol. :** Meristem is free of virus and is used to obtain virus free plants.

128. Answer (3)

**Sol. :** In some population interactions neither of the species is benefitted. In competition both the species are harmed (–, –).

129. Answer (2)

**Hint :** In sigmoid curve of logistic growth initial lag phase is followed by acceleration and deceleration and finally an asymptote, where resources are limited.**Sol. :** An asymptote is shown when population density reaches the carrying capacity *i.e.* carrying capacity = population density.

130. Answer (3)

**Hint :** Niche is specific part of habitat occupied by individuals of a species.**Sol. :** Ecological niche of an organism represents the range of conditions that it can tolerate, the resources it utilises and its functional role in ecosystem.

131. Answer (3)

**Sol. :** IRRI is situated in Philippines.

132. Answer (4)

**Sol. :** Baculoviruses attack insects and other arthropods hence are pathogens.*Trichoderma* are very common in root ecosystems.

133. Answer (4)

**Hint :** Major component of biogas is highly inflammable.**Sol. :** Methanogens produce methane which contribute 50-70% of total biogas mixture.

134. Answer (1)

**Sol. :**

Variety	Resistant to disease
a. Himgiri	– Hill bunt
b. Pusa Komal	– Bacterial blight
c. Karan rai	– White rust
d. Pusa sadabahar	– Leaf curl



135. Answer (2)

**Hint :** A bhindi variety called Parbhani Kranti is resistant to viral disease.**Sol. :** It is resistant to yellow mosaic virus.

136. Answer (2)

**Hint :** Jersey and Karan Fries are improved breeds of cattle.**Sol. :** American breed of chickens include New Hampshire and Plymouth Rock.

Mediterranean breed of chicken is Leghorn.

137. Answer (4)

**Hint :** Present in beverages like wine.**Sol. :** The chronic use of drugs and alcohol damage the nervous system and liver respectively.

138. Answer (2)

**Hint. :** "A" represent analgesic.**Sol. :** Natural cannabinoids are obtained from the inflorescence of *Cannabis sativa*. Morphine is extracted from the latex of *Papaver somniferum*.

139. Answer (4)

**Hint :** Identify an arthropod.**Sol. :** Marine water fishes are Bombay duck, Hilsa, Eel, Pomphret, Salmon and sardines which can be reared in pisciculture.

140. Answer (3)

**Hint :** Commonly known as sadabahar.**Sol. :** *Catharanthus roseus* is the source of anti-cancer drugs such as vinblastin and vincristin.

141. Answer (2)

**Hint :** The anthrone test is a highly sensitive test for fructose.**Sol. :** Mantoux test is used for diagnosis of tuberculosis and Schick test for diphtheria.

142. Answer (4)

**Hint :** Adenoma is tumor of glands.**Sol. :** Adenoma is a benign tumor of glands.

143. Answer (3)

**Hint :** Enzyme that catalyses reverse transcription.**Sol. :** HIV consists of RNA genome with reverse transcriptase surrounded by protein coat. Reverse transcriptase can synthesize DNA from RNA.

144. Answer (2)

**Hint :** HIV is mainly present in blood and semen.**Sol. :** Transmission of HIV generally occurs by transfusion of contaminated blood and blood products.

145. Answer (1)

**Hint :** A disease present since birth.

**Sol. :** HIV causes deficiency of immune system, acquired during the life time of an individual indicating that it is not a congenital disease. HIV infection may be congenital.

146. Answer (2)

**Hint. :** In human body, nearly half of lymphoid tissue is MALT.

**Sol. :** Lymphoid tissue which is located within the lining of the major tracts (respiratory, digestive and urogenital tracts) is called mucosa associated lymphoid tissue (MALT). It constitutes about 50% of the lymphoid tissue in human body.

147. Answer (4)

**Hint :** Graveyard of RBCs.

**Sol. :** Both bone marrow and thymus provide micro environment for the development and maturation of T-lymphocytes.

The secondary lymphoid organs provide the site for interaction of lymphocytes with antigens.

148. Answer (3)

**Hint :** Lobed structure which is located near the heart.

**Sol. :** Thymus and bone marrow are primary lymphoid organs, where immature lymphocytes differentiate into antigen sensitive lymphocytes.

149. Answer (1)

**Hint :** Connective tissue which is present in bone for hemopoiesis.

**Sol. :** Secondary lymphoid structures are spleen, lymph nodes, tonsils, Peyer's patches of small intestine and appendix.

150. Answer (4)

**Hint :** Protected environment will lead to reduced development of acquired immunity.

**Sol. :** Protected environment in early life of children in metro cities decrease their immunity due to decrease in antigenic stimulus.

151. Answer (2)

**Hint :** Identify the main inflammatory mediator.

**Sol. :** Noradrenaline also quickly reduces the symptoms of allergy. Histamine is the main mediator of inflammation.

152. Answer (3)

**Hint :** Identify the Ig found in low amounts in normal human body.

**Sol. :** IgE causes release of histamine from most cells. It also increases in number in parasitic infestations.

153. Answer (1)

**Hint :** Disease caused by *Entamoeba histolytica*.

**Sol. :** *Entamoeba histolytica* is a protozoan parasite in the large intestine of humans which cause amoebiasis (amoebic dysentery).

154. Answer (2)

**Hint :** Organism that is used in fermentation.

**Sol. :** Vaccines produced using recombinant DNA technology allow large scale production and hence, greater availability for immunization.

155. Answer (3)

**Hint :** Identify the disease which has been eradicated.

**Sol. :** First generation vaccines are whole organism vaccines, either live, weakened or killed.

Vaccine against typhoid, rabies, cholera, influenza and Salk polio vaccines are of killed type.

Small pox, OPV, BCG, influenza vaccines are attenuated.

156. Answer (3)

**Hint :** Step taking place after antigen-antibody interaction.

**Sol. :** Neutralization is conversion of virulent into non-virulent form of pathogen. Lysis involves the rupture of plasma membrane of pathogen due to attack of antibody.

157. Answer (1)

**Hint :** N terminal of immunoglobulin has the antigen binding site.

**Sol. :** One end of the antibody binds to antigen (the  $F_{ab}$  portion, so called because it is the fragment of the molecule which is antigen binding or paratope), and the other end which is crystallisable and therefore called  $F_c$  which is responsible for effector function.

158. Answer (3)

**Hint :** Antibody molecule is represented by  $H_2L_2$ .

**Sol. :** Each antibody is Y-shaped containing two light and two heavy chains connected with each other by disulphide bonds.

159. Answer (4)

**Hint :** Acquired immunity develops due to antigenic stimulus.

**Sol. :** Acquired immunity is pathogen specific and anamnestic secondary response is characterized by prior encounter with antigen resulting in formation of memory cells during clonal selection.

160. Answer (4)

**Hint :** Membrane containing goblet cells.

**Sol. :** Mucus membrane lining the respiratory, gastrointestinal and urogenital tract are examples of physical barriers of innate immunity. Mucus helps in trapping the microbes entering our body.

161. Answer (1)

**Hint :** Identify a disease caused by a virus.

**Sol. :** Vector of chikungunya is a female *Aedes* mosquito.

162. Answer (1)

**Hint :** HIV is a retro virus.

**Sol. :** Two identical single stranded RNA filaments are associated with reverse transcriptase in HIV.

163. Answer (3)

**Hint :** Preformed antibodies are transferred in passive immunity.

**Sol. :** When readymade antibodies are directly given to protect the body against a foreign agent, it is called passive immunity.

164. Answer (1)

**Hint :** Elephantiasis is also called filariasis.

**Sol. :** Sleeping sickness is a protozoan disease and elephantiasis occurs due to helminthic infection. *Aedes* serves as vector for dengue and yellow fever.

165. Answer (3)

**Hint :** Identify the connecting link between living organisms and non-living entities.

**Sol. :** Interferons are glycoproteins synthesized in virus infected cells and affect neighbouring cells by synthesizing translation inhibitory proteins. Cancer patients are given biological response modifiers such as  $\alpha$ -interferons which activate their immune system and help in destroying the tumor.

166. Answer (4)

**Hint :** Outbreeding can involve outcrossing, crossbreeding and interspecific hybridization.

**Sol. :** When breeding occurs between animals of same breed for 4-6 generations it is called inbreeding. A group of animals related by descent and similar in most characters like general appearance, features, size, configuration, etc., are said to belong to a breed.

167. Answer (3)

**Hint :** Identify a larvivorous fish.

**Sol. :** *Gambusia* feeds on mosquito larvae and helps control spread of vector borne diseases.

168. Answer (4)

**Hint :** Identify the genus of pathogen causing typhoid.

**Sol. :** Many fungi belonging to the genera *Microsporium*, *Trichophyton* and *Epidermophyton* are responsible for ringworm.

169. Answer (3)

**Hint :** Identify a toxic substance.

**Sol. :** Schizont has yellowish-brown pigment granules of haemozoin which is derived from the porphyrin part of haemoglobin in the red blood corpuscles.

170. Answer (3)

**Hint :** Identify the vector of malaria.

**Sol. :** *Plasmodium* multiplies within the body of female *Anopheles* to form sporozoites that reside in its salivary glands.

171. Answer (2)

**Hint :** Disease spread by contaminated food and water.

**Sol. :** *Salmonella typhi* generally enters the small intestine through contaminated food and water and migrates to other organs through blood. In severe cases death may also occur.

172. Answer (4)

**Hint :** Pneumonia causing pathogens can be bacteria, viruses or fungi.

**Sol. :** In pneumonia, the alveoli get filled with fluid leading to severe problems in respiration. Symptoms of pneumonia include fever, chills, cough and headache.

173. Answer (4)

**Hint :** Identify a viral disease.

**Sol. :** Dysentery, plague, diphtheria etc. are some of the bacterial diseases in man. Common cold is a viral disease.

174. Answer (2)

**Hint :** Disease caused by activation of proto oncogenes to oncogenes.

**Sol. :** Diseases which are easily transmitted from one person to another are called infectious diseases. Some of the infectious diseases like AIDS are fatal.

175. Answer (1)

**Hint :** Hygienic conditions are required for good health.

**Sol.** : Awareness about disease and their effects on different bodily functions, vaccination (immunisation) against infectious diseases, proper disposal of wastes, control of vectors and maintenance of hygienic food and water resources are necessary for achieving good health.

176. Answer (1)

**Hint** : Action of cyclosporin drug inhibits this immune response.

**Sol.** : Cell-mediated immune response comprising cytotoxic T cells (killer cells) is chiefly responsible for graft rejection.

177. Answer (2)

**Hint** : Type of breeding to obtain a pureline.

**Sol.** : Inbreeding increases homozygosity. Inbreeding is essential to evolve purelines in any animal and elimination of harmful recessive genes.

178. Answer (3)

**Hint** : Smack is diacetylmorphine.

**Sol.** : Morphine is extracted from the latex of poppy plant *Papaver somniferum*. Heroin is obtained by acetylation of morphine (diacetyl morphine) commonly called smack which is a white, odourless and bitter crystalline compound. Generally, it is taken by snorting or injection. It is a depressant and slows down body functions.

179. Answer (1)

**Hint** : Antibody present in body fluids.

**Sol.** : Colostrum is a yellowish liquid substance that a nursing mother produces from her breasts 25-48 hours after delivery which is very important in the transfer of antibodies to the newborn.

180. Answer (4)

**Hint** : MOET is not used in amphibians.

**Sol.** : Bony fishes and amphibians exhibit external fertilization, so the fertilized structure is not transferred into their body. MOET cannot be used in these cases due to external development of embryo.

